

Names of Parts

Digital Camera

Optio T10

Operating Manual



To ensure the best performance from your camera, please read the Operating Manual before using the camera.

Front

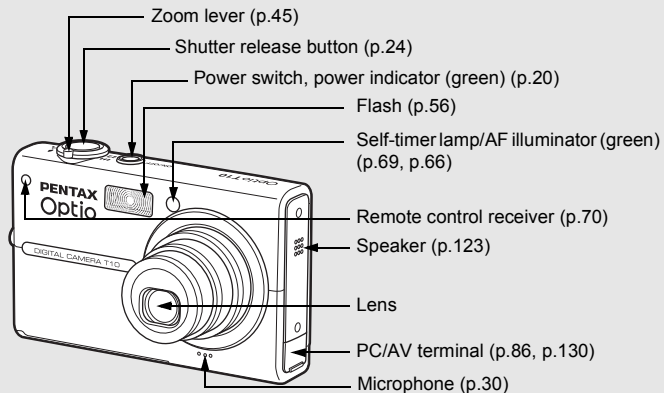

Back

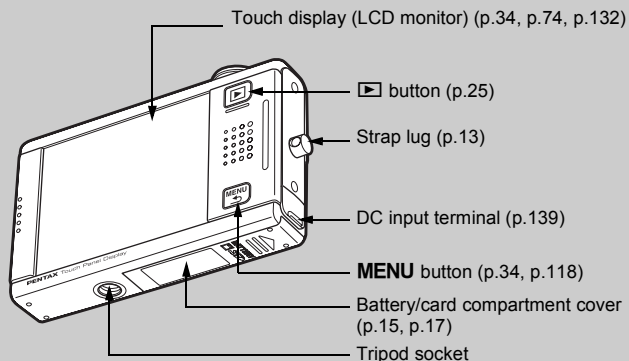

Accessing the Camera Settings

Simply press the  button or **MENU** button, or touch the LCD monitor to set up and operate the camera.

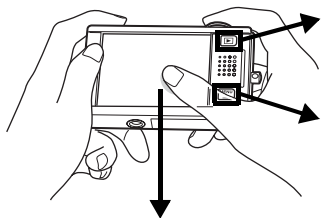

Press the button.

This switches the camera to Playback mode to play back captured images and sound files (p.25).

Press the **MENU** button.

This displays menus to adjust the recorded pixels, EV compensation, and other advanced shooting settings (p.34, p.118).

Touch the LCD monitor.

This displays the [Capture Toolbar] ([Playback Toolbar] in Playback mode) to set the flash, self-timer, and other frequently used functions (p.34, p.74).

Using the touch display



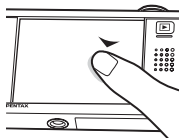

Use the touch display by directly touching the LCD monitor with your finger. It is recommended that you use the stylus when precise operations are required such as editing images after shooting.



Touch

This refers to touching the touch display with your finger or the stylus and then releasing it.

Touch an icon to select it, and release to set that option (a guide display appears describing the function of the selected icon before it is set). Touch an item for more than two seconds to cancel the selection. Use this to display toolbars or select icons.

Press and hold down an arrow icon (   ) to change the setting or switch screens in some menus.



Double-touch

This refers to touching the touch display twice quickly.

Use this to directly set a function without having to display the guide display.

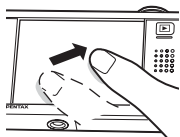

Drag

This refers to touching and moving your finger or stylus across the touch display.

Use this to change the displayed portion of an image or to change a setting by sliding the cursor along a setting bar. If you inadvertently select the wrong icon, drag your finger or the stylus from that icon to the desired icon, and then release your finger or the stylus to reselect.

Monitor Indications

These are the indications on the monitor during Capture or Playback mode.

Capture Mode

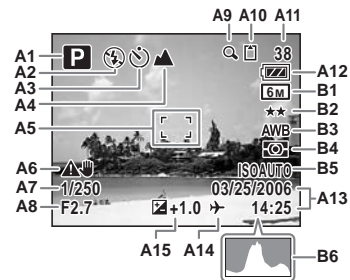

Playback Mode

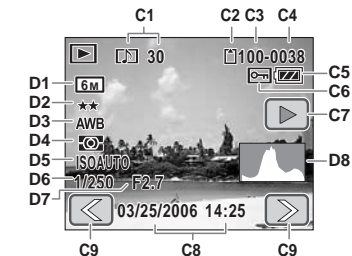

A1	Shooting mode	42
A2	Flash mode	56
A3	Drive mode	35
A4	Focus mode	63
A5	Focus frame	65
A6	Camera shake warning	62
A7	Shutter speed	48
A8	Aperture	48
A9	Digital zoom	46
A10	Memory status	20
A11	Remaining image storage capacity	50, 52
A12	Battery level	16
A13	Current date and time	121
A14	World time setting	125
A15	EV compensation value	53
B1	Recorded pixels	49
B2	Quality level	49
B3	White balance	58
B4	AE metering	55
B5	Sensitivity	67
B6	Histogram	54

C1	Voice memo	105
C2	Memory status	20
C3	Folder name	129
C4	File number	
C5	Battery level	16
C6	Protect	91
C7	Voice memo playback	81
C8	Shooting date and time	
C9	Previous/Next	25
D1	Recorded pixels	49
D2	Quality level	49
D3	White balance	58
D4	AE metering	55
D5	Sensitivity	67
D6	Shutter speed	48
D7	Aperture	48
D8	Histogram	54

* D1 to D8 only appear when the display is set to [Standard+Histogram] (p.76).

* B1 to B6 only appear when the display is set to [Standard+Histogram] (p.40).

Overview of the Operating Manual

You should read the chapters “Getting Started” and “Camera Features” while operating the Optio T10 to familiarize yourself with how the camera works. Refer to the other chapters as necessary for information on additional camera features.

1 Getting Started p.12

This chapter explains what you need to know about the camera. Be sure to read it and follow the instructions.

2 Camera Features p.24

This chapter explains the main features of the camera including basic operations such as taking pictures, recording movies and sounds, and printing images.

3 Taking Pictures p.34

This chapter goes into more detail about various ways to take pictures, how to set relevant functions, and how to get the most out of these functions.

4 Playing Back and Editing Images p.74

This chapter explains how to play back, delete, and edit still pictures, movies, and recorded sound.

5 Printing Images p.110

This chapter explains how to print still images using PictBridge and the DPOF printing setting with a DPOF-compatible printer or photo processing lab.

6 Settings p.118



This chapter explains how to format the SD Memory Card or the built-in memory, set the date and time, sound, LCD monitor brightness, and other camera-related functions.

7 Appendix p.137

This section details optional accessories and troubleshooting tips.

* For information on transferring images to a PC and installing ACDSsee for PENTAX, see the supplied “PC Connection Manual”. For details on editing and printing images on a PC, see Help in the ACDSsee for PENTAX software for related topics.

The symbols used in this operating manual are explained below.

	This indicates precautions to be taken when operating the camera.
	This indicates information that is useful to know.
	This indicates the reference page for an explanation of a related operation.

1**2****3****4****5****6****7**

Thank you for buying the PENTAX Digital Camera.

Please read this manual before using the camera in order to get the most out of all the features and functions. Keep this manual safe, as it can be a valuable tool in helping you to understand all the camera's capabilities.

Regarding copyrights

Images taken using the PENTAX Digital Camera that are for anything other than personal enjoyment cannot be used without permission according to the rights as specified in the Copyright Act. Please take care, as there are even cases where limitations are placed on taking pictures even for personal enjoyment during demonstrations, performances or of items on display. Images taken with the purpose of obtaining copyrights also cannot be used outside the scope of use of the copyright as laid out in the Copyright Act, and care should be taken here also.

Regarding trademarks

- PENTAX, Optio and smc PENTAX are trademarks of PENTAX Corporation.
- The SD logo  is a trademark.
- QuickTime™ and QuickTime logo are trademarks used under license. The QuickTime logo is registered in U.S. and other countries.
- Red Eye software © 2003-2005 FotoNation Inc. In Camera Red Eye -- covered by U.S. Patent No. 6,407,777. Other patents pending.
- All other brands or product names are trademarks or registered trademarks of their respective owners.

To users of this camera

- There is a possibility that recorded data may be erased or that the camera may not function correctly when used in surroundings such as installations generating strong electromagnetic radiation or magnetic fields.
- The liquid crystal panel used in the LCD display is manufactured using extremely high precision technology. Although the level of functioning pixels is 99.99% or better, you should be aware that 0.01% or fewer of the pixels may not illuminate or may illuminate when they should not. However, this has no effect on the recorded image.

This product supports PRINT Image Matching III. PRINT Image Matching enabled digital still cameras, printers and software help photographers to produce images more faithful to their intentions. Some functions are not available on printers that are not PRINT Image Matching III compliant.

Copyright 2001 Seiko Epson Corporation. All Right Reserved.

PRINT Image Matching is a trademark of Seiko Epson Corporation. The PRINT Image Matching logo is a trademark of Seiko Epson Corporation.

Regarding PictBridge

PictBridge allows the user to connect the printer and digital camera directly, using the unified standard for the direct printout of images. You can print images directly from the camera through a few simple operations.

Regarding Product Registration

In order to service you better, we request that you complete the product registration, which can be found on the CD-ROM supplied with the camera or the PENTAX website. Thank you for your cooperation.
Refer to the PC Connection Manual (bottom right of the front side) for more information.

- There is a possibility that the illustrations and the display screen of the LCD monitor in this manual are different from the actual product.

Contents

Overview of the Operating Manual.....	1
Contents	3
USING YOUR CAMERA SAFELY	7
About the Camera	7
About the Battery Charger and the AC Adapter	9
Care to be Taken During Handling.....	10
1 Getting Started.....	12
Checking the Contents of the Package	12
Attaching the Strap.....	13
Installing the Battery.....	14
Charging the Battery.....	14
Installing the Battery	15
Removing the Battery	15
Installing the SD Memory Card	17
Removing the SD Memory Card.....	18
Turning the Camera On and Off.....	20
Checking the Memory Card.....	20
Initial Settings	21
Setting the Language and the Date and Time.....	21
2 Camera Features.....	24
Enjoy Taking Pictures.....	24
Enjoy Recording Movies.....	28
Enjoy Recording Sounds.....	30
Enjoy Printing Images	32

3 Taking Pictures	34
Setting the Shooting Functions	34
Calling Up Frequently Used Functions	36
Saving the Current Camera Settings	38
Displaying Shooting Information in Capture Mode	40
Selecting a Shooting Mode	42
Selecting the Shooting Mode in the Capture Palette	42
Composing Your Shot	45
Using the Zoom	45
Taking Pictures with the Built-in Photo Frames	47
Adjusting the Size, Quality Level, Brightness, and Color Tone	48
Setting the Recorded Pixels, Quality Level, and Frame Rate	49
Setting the Exposure (EV Compensation)	53
Selecting the AE Metering	55
Using the Flash	56
Adjusting the Color Balance (White Balance)	58
Adjusting the Sharpness, Saturation, and Contrast	60
Focusing	61
Selecting the Focus Mode	63
Setting the Autofocus Conditions	65
Setting the Sensitivity	67
Taking Pictures	68
Using the Self-timer	69
Using the Remote Control	70
Taking Continuous Pictures	72
Setting the Instant Review Time	73

4	Playing Back and Editing Images	74
	Setting the Playback Functions	74
	Displaying Shooting Information	76
	Playing Back Images, Movies, and Sound Files	78
	Turning on the Camera in Playback Only Mode	78
	Rotating Images	78
	Magnifying Images	79
	Nine-image Display	80
	Playing Back an Image with a Voice Memo	81
	Playing Back Movies	82
	Playing Back Sound	83
	Slideshow	84
	Playing Back on a TV	86
	Deleting Images and Sound Files	88
	Deleting One Image or Sound File	88
	Deleting All Images and Sound Files	89
	Deleting Selected Images and Sound Files	90
	Protecting Images and Sound Files from Deletion	91
	Editing Images and Movies	93
	Changing the Image Size and Quality (Resize)	93
	Deleting Unwanted Parts of an Image (Trimming)	94
	Making Drawings and Adding Stamps	95
	Adding a Frame to an Image (Frame Composite)	99
	Changing the Image Color Tone (Color Filter)	101
	Changing the Image Brightness (Bright Filter)	102
	Digital Filter Effects	103
	Removing Red-eye	104
	Adding Sound to an Image (Voice Memo)	105
	Setting an Image for the Start-up Screen	106
	Saving a Frame from a Movie as a Still Image	107
	Copying Images and Sound Files	108

5	Printing Images	110
	Printing with DPOF	110
	Applying the DPOF Settings to Each Image	110
	Applying the DPOF Settings to All Images	112
	Direct Printing with PictBridge	113
	Connecting the Camera to the Printer	113
	Printing Single Image	114
	Printing All Images	116
	Printing Using the DPOF Settings	116
	Disconnecting the USB Cable	117
6	Settings	118
	Using the Setting Menu	118
	Formatting an SD Memory Card and the Built-in Memory	120
	Changing the Date and Time	121
	Changing the Sound Settings	123
	Setting the World Time	125
	Changing the Display Language	128
	Changing a Folder Name	129
	Changing the USB Connection Mode	130
	Changing the Video Output Format	131
	Adjusting the Brightness of the LCD Monitor	132
	Using the Power Saving Function	133
	Setting Auto Power Off	134
	Setting the Guide Display	135
	Returning Changed Settings to Their Defaults (Reset)	136
7	Appendix	137
	Charging the Battery Abroad	137
	Main Socket Types in the Major Countries and Regions of the World	138
	Using the AC Adapter	139
	Optional Accessories	141
	Messages	142
	Troubleshooting	144
	Main Specifications	148
	WARRANTY POLICY	153
	Index	157

USING YOUR CAMERA SAFELY

Sufficient attention has been paid to the safety of this product but please pay particular attention to the warnings indicated by the following symbols during use.



Warning

These symbols indicate that it is possible that the user may experience serious difficulties if the warnings are not heeded.



Caution

These symbols indicate that it is possible that the user may experience minor or middling difficulties or physical difficulties if the warnings are not heeded.

About the Camera



Warning

- Do not attempt to take the camera apart or modify the camera. High internal voltages are present which can produce electric shock.
- If internal parts of the camera become exposed as a result of the camera being damaged, do NOT touch the exposed portions, as there is a danger of receiving an electric shock.
- Keep the provided stylus away from infants and children to prevent possible injury or death.
- To avoid the risk of it being swallowed by mistake, keep the SD Memory Card out of the reach of small children. Seek medical attention immediately if a card is accidentally swallowed.
- Keep the provided strap away from infants and children to prevent possible injury or suffocation.
- Use an AC adapter that is of the power and voltage specified for exclusive use with this product. The use of an AC adapter other than that specified exclusively for use with this product may cause fire or electric shocks.
- If the camera emits smoke or a strange smell, or in the event of any other irregularity, stop using the camera immediately, remove the battery and contact your nearest PENTAX Service Center. Continued use of the camera may result in fire or electric shock.

 **Caution**

- Never try to disassemble or short the battery. Also, do not dispose of the battery in fire, as it may explode.
- Do not charge any batteries other than rechargeable lithium-ion battery D-LI8. The battery could explode or catch fire.
- Do not place your finger on the flash when it is discharging as there is a risk of burns.
- Do not discharge the flash while it is touching your clothing as there is a risk of discoloring.
- If any of the battery leakage should come in contact with your eyes, do not rub them. Flush your eyes with clean water and get medical attention immediately.
- If any of the battery leakage should come in contact with skin or clothes, wash the affected areas thoroughly with water.
- Remove the battery from the camera immediately if it becomes hot or begins to smoke. Be careful not to burn yourself during removal.
- Some portions of the camera heat up during use, so please take care, as there is a risk of low temperature burns if such portions are held for long periods of time.
- Should the LCD be damaged, be careful of glass fragments. Also, be careful not to allow the liquid crystal to get on your skin or in your eyes or in your mouth.
- To avoid scratching the display screen of the LCD monitor, use only your finger or the provided stylus to make selections. Do not use sharp objects such as pens or pencils as they may cause the camera to malfunction.

About the Battery Charger and the AC Adapter

Warning

- Do not use the product at a voltage other than the specified voltage. Use with a power source or voltage other than that designed can cause a fire or electrical shock. The specified voltage is 100 - 240V AC.
- Do not disassemble or modify the product. This can cause a fire or electrical shock.
- If the generation of smoke or strange odor from the product or other abnormality occurs, immediately discontinue using and consult a PENTAX Service Center. Continuing to use the product can cause a fire or electrical shock.
- If water should happen to get inside the product, consult a PENTAX Service Center. Continuing to use the product can cause a fire or electrical shock.
- If lightning should be present during use of the battery charger or AC adapter, unplug the power cord and discontinue use. Continuing to use the product can cause damage to the equipment, fire or electrical shock.
- Wipe off the plug of the power cord if it should become covered with dust. This can cause a fire.

Caution

- Do not place heavy objects on the AC plug cord, allow heavy objects to drop onto it or allow the AC plug cord to become damaged due to excessive bending. If the AC plug cord becomes damaged, consult a PENTAX Service Center.
- Do not short or touch the output terminals of the product while it is still plugged in.
- Do not plug in the AC plug cord with wet hands. This can cause an electrical shock.
- Do not subject the product to strong impacts or allow it to drop onto a hard surface. This can cause a malfunction.
- Do not use the battery charger to charge batteries other than rechargeable lithium-ion battery D-LI8. This can cause overheating or malfunctions.

Care to be Taken During Handling

- Take the Worldwide Service Network that is included in the package. This will be useful if you experience problems abroad.
- When the camera has not been used for a long time, confirm that it is still working properly, particularly prior to taking important pictures (such as at a wedding or during traveling). Contents of the recording cannot be guaranteed if recording, playback or transferring your data to a computer, etc. is not possible due to a malfunction of your camera or recording media (SD Memory Card), etc.
- The lens on this camera is not exchangeable. The lens is not removable.
- Do not clean the product with organic solvents such as thinner, alcohol or benzene.
- Fingerprints and smudges may be removed from the display screen of the LCD monitor by wiping them gently with a soft, dry cloth.
- Places of high temperature and humidity should be avoided. Particular care should be taken regarding vehicles, which can become very hot inside.
- Storing the camera where pesticides and chemicals are handled should be avoided. Remove from case and store in a well-ventilated place to prevent the camera from becoming moldy during storage.
- Do not use the camera where it may come in contact with rain, water or any other liquid, because the camera is not weather, water, or liquid resistant.
- Ensure that the camera is not subjected to substantial vibrations, shocks or pressure as this may cause damage, malfunction, or a loss in waterproof performance. Place the camera on a cushion for protection when the camera is subjected to the vibrations of a motorbike, car, ship, etc. If the camera is subjected to substantial vibrations, shocks or pressure, take your camera to your nearest PENTAX Service Center and have it checked.
- The temperature range in which the camera can be used is 0°C to 40°C (32°F to 104°F).
- The liquid crystal display will become black at a high temperature but will return to normal when normal temperatures are returned to.

- The response speed of the liquid crystal display becomes slow at low temperatures. This is due to the properties of the liquid crystal and is not a fault.
- Periodic checks are recommended every 1 to 2 years in order to maintain high performance.
- If the camera is subjected to rapid temperature changes, condensation may form on the inside and outside of the camera. Therefore put the camera in a bag or plastic bag, and take the camera out when the difference in temperature has subsided.
- Avoid contact with garbage, dirt, sand, dust, water, toxic gases, salt, etc. as this may cause damage to the camera. If rain or drops of water get onto the camera, please wipe dry.
- Refer to “Precautions When Using an SD Memory Card” (p.19) regarding the SD Memory Card.
- Please note that formatting an SD memory card or built-in memory will delete all data, however it may still be possible to recover that data using off-the-shelf data recovery software. Please manage your camera’s memory at your own risk.
- Please do not press forcefully on the LCD monitor. This could cause breakage or malfunction.
- Be careful not to sit down with the camera in your back pocket as this may damage the exterior of the camera or the LCD monitor.
- When using a tripod with the camera, be careful not to overtighten the screw in the tripod socket on the camera.
- The AC plug cord supplied with the camera is for exclusive use with the battery charger D-BC8. Do not use it with any other equipment.

Recycling Batteries



This symbol indicates that the battery is recyclable. Cover the terminals with insulating tape and take the battery to a store displaying this symbol.

Li-ion

LED Safety Standard

This device is a digital still camera that conforms to the safety standard (IEC60825-1) for a Class 1 LED product.

1 Getting Started

Checking the Contents of the Package

If anything is missing or damaged, contact your local authorized PENTAX dealer.

1
Getting Started



Camera
Optio T10

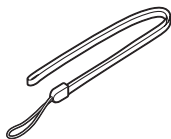

Strap O-ST20 (*)



Stylus pen
O-SP45

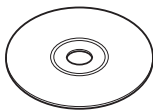

Software
(CD-ROM) S-SW45

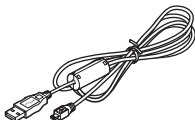

USB cable
I-USB17 (*)

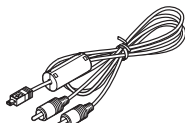

AV cable
I-AVC7 (*)



Rechargeable lithium-ion
battery D-LI 8 (*)

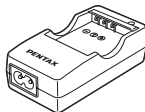

Battery charger
D-BC8 (*)



AC plug cord
D-CO2 (*)



Operating Manual
(this manual)

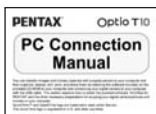

PC Connection Manual

Items marked with an asterisk (*) are also available as optional accessories. For other optional accessories, refer to "Optional Accessories" (p.141).

Attaching the Strap

Attach the camera strap as shown below.

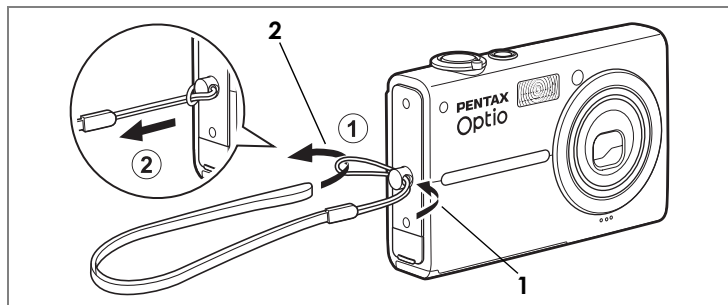

- 1** Pass the narrow end of the strap (①) through the strap lug on the camera.
- 2** Pass the other end of the strap through the loop (①) and pull tight (②).



Memo

The stylus can be attached to the strap for your convenience, if necessary.

Installing the Battery

Charging the Battery

1
Getting Started

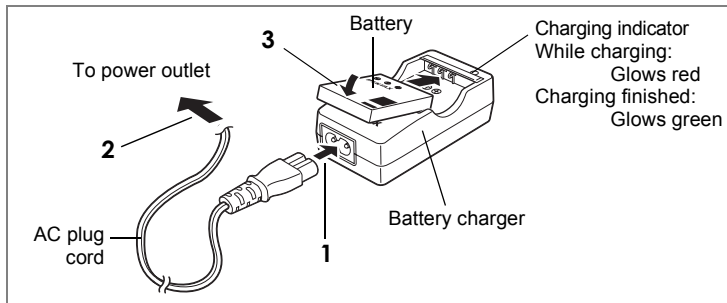

Use the battery charger to charge the battery before using it in the camera for the first time, after a long period of non-use, or when the [Battery depleted] message appears.

- 1 Connect the AC plug cord to the battery charger.**
- 2 Plug the AC plug cord into a power outlet.**
- 3 Place the battery in the charger with the PENTAX logo facing up.**

The charging indicator glows red while the battery is charging and changes to green when charging is finished.

- 4 Remove the battery from the battery charger when fully charged.**



Memo

- The time required to fully charge the battery is about 100 minutes (max.). The appropriate ambient temperature for charging the battery is 0°C to 40°C (32°F to 104°F). The charging time may vary depending on the ambient temperature and other conditions.
- The battery has reached the end of its service life when it starts to run down soon after being charged. Replace with a new battery.

Caution

- Do not use the battery charger to charge batteries other than the rechargeable lithium-ion battery D-LI 8, as the charger may overheat or become damaged.
- If the battery is inserted correctly but the charging indicator fails to light, the battery may be faulty or exhausted. Replace with a new battery.

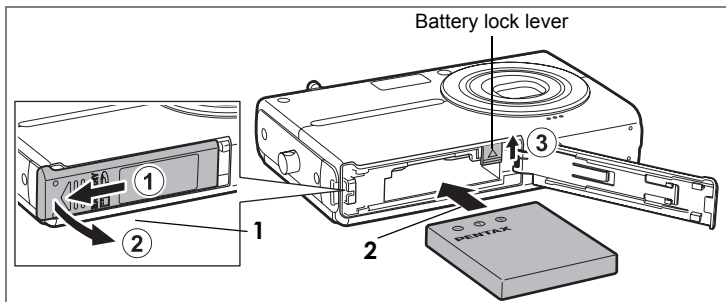
Installing the Battery

Use only the battery that is provided with the camera. Charge the battery before using it in the camera for the first time.

1 Open the battery/card compartment cover.

Slide the battery/card compartment cover in the direction of ① and flip the cover open in the direction of ②.

2 Use the side of the battery to lift the battery lock lever upward ③, and insert the battery with the PENTAX logo as shown.

Push the battery in until it is locked in place.

3 Close the battery/card compartment cover.**Removing the Battery****1 Open the battery/card compartment cover.****2 Release the battery by using your finger to push the battery lock lever upward ③.**

The battery will be ejected. Pull the battery out of the camera.

**Caution**

- This camera uses the rechargeable lithium-ion battery D-LI 8. Use of any other type of battery may damage the camera and cause malfunction.
- If the battery is incorrectly inserted, malfunction may result.
- Do not remove the battery while the camera is turned on.
- If the camera will not be used for a long period of time, remove the battery.
- The date and time may revert to the default setting if the battery is removed from the camera for an extended period of time.

Image Recording Capacity and Playback Time

(at an ambient temperature of 23°C with the LCD monitor on and the battery fully charged)

Image Recording Capacity *1 (with the flash used for 50% of the shots)	Playback Time *2
Approx. 130 pictures	Approx. 90 min.

*1: Recording capacity shows the approximate number of shots recorded during CIPA-compliant testing (with LCD monitor on and flash used for 50% of the shots at an ambient temperature of 23°C). Actual performance may vary depending on operating conditions.



*2: According to the results of PENTAX in-house testing.

**Memo**

- Battery performance may be temporarily reduced at low temperatures.
- Be sure to take a spare battery with you when traveling abroad or to a cold region, or if you intend to take a lot of pictures.

Battery Level Indicator

The battery level can be checked by observing the  indicator on the LCD monitor.

Screen Display	Battery Status
 (green)	Adequate power remains.
 (green)	Battery is running low.
 (red)	Battery is running very low.
Battery depleted	The camera will turn off after this message appears.

Installing the SD Memory Card

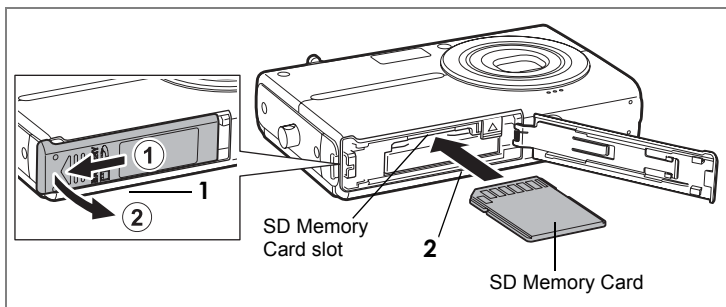

This camera uses an SD Memory Card. When an SD Memory Card is installed in the camera, captured images and sound files are saved on the card. If a card is not installed, they are saved in the built-in memory (p.20).

Caution

- Make sure the camera is turned off before inserting or removing the SD Memory Card.
- Be sure to format an SD Memory Card that is new or has been used on another camera. Refer to "Formatting an SD Memory Card and the Built-in Memory" (p.120) for instructions on formatting.

1 Open the battery/card compartment cover.

Slide the battery/card compartment cover in the direction of ① and flip the cover open in the direction of ②.

2 Insert the SD Memory Card into the SD Memory Card slot so that the back of the card (the side without the label) is facing up toward the lens.

Push the card in until it clicks. Make sure to insert the card all the way into the slot or images and sound may not be recorded properly.

3 Close the battery/card compartment cover.



Memo

- The number of pictures that can be stored on an SD Memory Card will vary depending on the capacity of the card and the image resolution and quality level selected (p.50, p.52).
- The power indicator blinks while the SD Memory Card is being accessed (data is being recorded or read).

Backing Up Data

The camera may not be able to access data in the built-in memory in the case of a malfunction. Use a computer or other device to back up important data in the case of a malfunction.

Removing the SD Memory Card

- 1 Open the battery/card compartment cover.**
- 2 Push the card into the SD Memory Card slot to eject it.**
Pull the card out.
- 3 Close the battery/card compartment cover.**

Precautions When Using an SD Memory Card

- The SD Memory Card is equipped with a write-protect switch. Setting the switch to LOCK write-protects the SD Memory Card. When the SD Memory Card is write-protected, the existing data is protected, and the recording of new data and deletion of existing data or formatting of the card is prohibited.
🔒 appears on the LCD monitor when the card is write-protected.
- Be careful when removing the SD Memory Card immediately after using the camera, as the card may be hot.
- Do not remove the SD Memory Card or turn the camera off while data is being saved to the card, images or sound files are being played back, or the camera is connected to a computer with the USB cable, as this may cause the data to be lost or the card to be damaged.
- Do not bend the SD Memory Card or subject it to violent impact. Keep it away from water and store away from high temperature.
- Do not remove the SD Memory Card during formatting as this may damage the card and render it unusable.
- The data on the SD Memory Card may be deleted in the following circumstances. PENTAX does not accept any liability for data that is deleted.
 - ① when the SD Memory Card is mishandled by the user.
 - ② when the SD Memory Card is exposed to static electricity or electrical interference.
 - ③ when the card has not been used for a long time.
 - ④ when the card is ejected or the battery is removed while the data on the card is being recorded or accessed.
- The SD Memory Card has a limited service life. If it is not used for a long time, the data on the card may become unreadable. Be sure to regularly make a backup of important data on a computer.
- Avoid using or storing the card where it may be exposed to static electricity or electrical interference.
- Avoid using or storing the card in direct sunlight or where it may be exposed to rapid changes in temperature or to condensation.
- When using an SD Memory Card with a slow recording speed, recording may stop while you are taking movies even when there is adequate space in the memory, or shooting and playback may take a long time.
- For information on compatible SD Memory Cards, visit the PENTAX website or contact your nearest PENTAX Service Center.

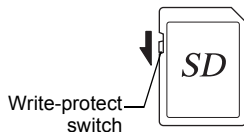

Turning the Camera On and Off

1 Getting Started

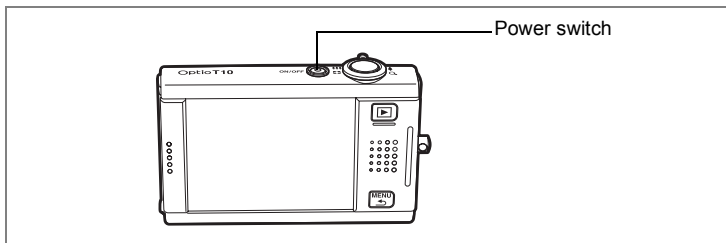



1 Press the power switch.

The camera turns on and is ready to take pictures (Capture mode). If the Initial Setting screen appears when you turn the camera on, follow the procedure on p.21 to make the initial settings.

2 Press the power switch again.

The camera turns off and the power indicator light goes off.

Checking the Memory Card

The memory card is checked automatically when the camera turns on, and an icon for the built-in memory or SD Memory Card appears on the LCD monitor.  appears on the LCD monitor when an SD Memory Card is inserted, and  appears when there is no SD Memory Card inserted. When  appears on the LCD monitor, images and sound files will be saved in the built-in memory.

The [Card locked] message appears when the write-protect switch on the SD Memory Card is in the locked position. Images and sound cannot be recorded when the write-protect switch is locked.

Memory status



Initial Settings

Set the language, time, and date before using the camera for the first time.

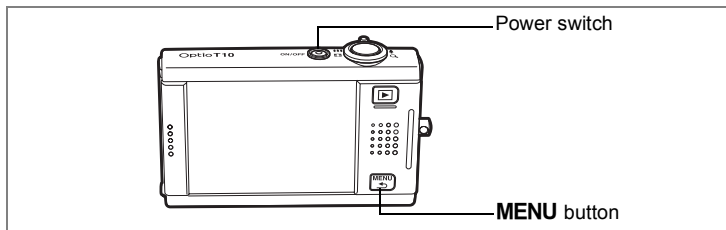

The Initial Setting screen appears when the camera is turned on for the first time. Perform the operations below to set the language and the current date and time.

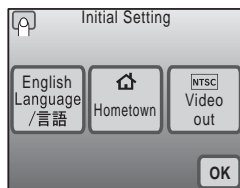

Setting the Language and the Date and Time

1 Touch [Language/言語].

The Language/言語 screen appears.



2 Choose a language from the screen display.

If the desired language does not appear, touch the arrow icons to advance the screen and select the language.

The Initial Setting screen appears in the selected language.

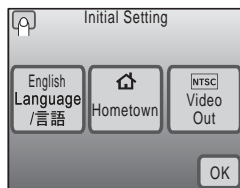

[Hometown] and [Video Out] will appear in the selected language. If [Hometown] or [Video Out] is not correctly displayed, touch the flashing icon on the LCD monitor and change the setting.

3 Touch [OK].

The Date Adjust screen appears.

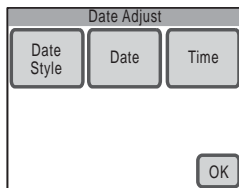

Caution

If the **MENU** button is pressed without touching [OK] on the Initial Setting screen, the language will not be set and the Date Adjust screen appears. In this case, the Initial Setting screen will appear next time you turn the camera on.

[Hometown], [Video Out], and [Date Style] are automatically set according to the language selected on the Initial Setting screen. To change these settings, refer to the pages below.

- [Hometown] : “Setting the Destination” (p.125)
- [Video Out] : “Changing the Video Output Format” (p.131)
- [Date Style] : “Changing the Date and Time” (p.121)

4 Touch [Date Style].

The Date Style screen appears.

5 Touch the arrow icons (◀▶) to choose the display style of the year, month, and day.

Select [mm/dd/yy], [dd/mm/yy] or [yy/mm/dd].

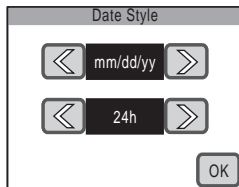

6 Touch the arrow icons (◀▶) to choose the time display style.

Select [24h] (24-hour display) or [12h] (12-hour display).

7 Touch [OK].

The setting is saved and the screen returns to the Date Adjust screen.

8 Touch [Date].

The Date screen appears.

9 Touch the arrow icons (⬆️⬇️) to set the current date.**10 Touch [OK].**

The setting is saved and the screen returns to the Date Adjust screen.

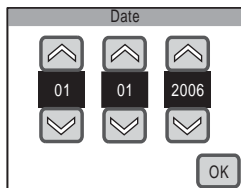
**11 Touch [Time].**

The Time screen appears.

12 Touch the arrow icons (⬆️⬇️) to set the time.**13 Touch [OK].**

The setting is saved and the screen returns to the Date Adjust screen.

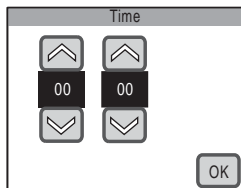
**14 Touch [OK].**

The camera returns to Capture mode.

⚠️ Caution

If the **MENU** button is pressed without touching [OK] on the Date Adjust screen, the camera will return to Capture mode without setting the time. In this case, the Date Adjust screen will appear next time you turn the camera on.

The set language, date, and time can be changed. Refer to the pages below for instructions.

- To change the language: “Changing the Display Language” (p.128)
- To change the date and time: “Changing the Date and Time” (p.121)

2 Camera Features

Enjoy Taking Pictures

You can take beautiful pictures by simply composing your picture and pressing the shutter release button. To view and edit the pictures you have captured, just touch the LCD monitor to perform the desired operation. This section looks at the basics of how to capture, play back, and edit pictures.

2

Camera Features

1 Point the Camera

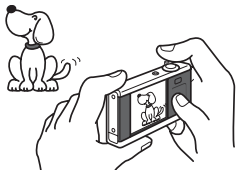

Turn on the camera (p.20) and point it in the direction of your subject. To prevent camera shake, hold the camera steady with both hands.

2 Compose Your Shot



Compose your shot using the LCD monitor. You can use the zoom lever to choose the area you want to capture (p.45).

3 Focus On the Subject

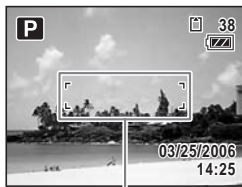

Focus frame

Lightly press the shutter release button to set the focus.

The focus frame on the LCD monitor turns green if the subject is in focus.

- The focus frame does not appear if the subject is not in focus.



Memo

Lightly pressing the shutter release button is referred to as pressing it "halfway". When the shutter release button is pressed halfway, the focusing point and exposure (brightness) lock. When you remove your finger from the shutter release button, the locked focusing point and exposure are canceled.

4 Take the Picture



After the shutter release button is pressed halfway (which locks in the focusing point and exposure values), press it all the way down to take a picture.

The captured image appears on the LCD monitor for one second (Instant Review) and is saved.

- The Instant Review time can be adjusted (p.73). To delete the image without saving it, touch the icon during Instant Review.



Memo

- Pressing the shutter release button all the way down is referred to as pressing it “fully”.
- Pressing the shutter release button also allows you to take pictures continuously (p.72). In addition, self-timer (p.69) and remote control (p.70) enable you to take pictures hands-free.

Using the Flash

By default, the flash is set to automatically fire when taking pictures in low light conditions. You can change the flash mode setting (p.56) to turn off the flash, reduce the brightness of the picture, prevent the subject from appearing with red eyes, and perform other functions.

Setting the flash mode

- ▶ Touch the LCD monitor → [Capture Toolbar] → .

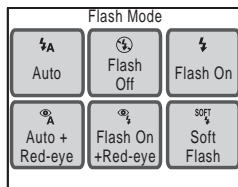

5 Play Back the Images



After taking a picture, press the button to switch to Playback mode. The captured image appears on the LCD monitor (p.74). Touch the arrow icons () to play back the images in order.

In Playback mode, you can magnify (p.79), delete (p.88), or rotate the images (p.78).

Additionally, you can view the images in a nine-image display (p.80) or as a slideshow (p.84).

Selecting the function for the displayed image

- ▶ In Playback mode, touch the LCD monitor → [Playback Toolbar] → select the function.

Viewing Images on a TV

The pictures that you take can also be viewed on a TV or other AV equipment so that everyone can enjoy them (p.86).

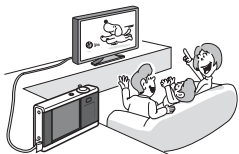

6 Edit an Image

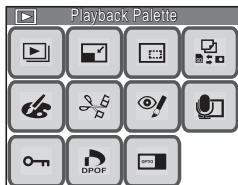

You can edit captured images (p.93).

You can change the size and quality level (p.93), trim an image (p.94), draw a picture (p.95), add stamps (p.95), add a frame (p.99), change the brightness (p.102), add sound (p.105), correct images where the flash has caused the subject to appear with red eyes (p.104), and more.

Selecting the editing method

- ▶ In Playback mode, touch the LCD monitor → [Playback Toolbar] →

Various Editing Functions



Digital Filters

Use these to soften an image, give the image the look of an illustration, change the width of the subject to appear broader or more slender (p.103).

Selecting the editing method

- ▶ On the [Playback Palette], double-touch → or .



My Drawing

Use the supplied stylus to draw pictures on an image, add stamps, create a stamp from part of the image, and more (p.95).

Tips on Taking Pictures

2

Adjusting the Shooting Conditions

You can adjust the shooting conditions based on your creative intent.

- You can change the recorded pixels and quality level of the pictures depending on how you intend to use them (p.93).
 - ▶ **MENU button** → [Rec. Mode 1] → [Recorded Pixels] or [Quality Level]
- You can adjust the brightness of the picture.

“Setting the Exposure (EV Compensation)” (p.53)

 - ▶ **MENU button** → [Rec. Mode 2] → [EV Compensation]

“Selecting the AE Metering” (p.55)

 - ▶ **MENU button** → [Rec. Mode 1] → [AE Metering]
- You can adjust the color balance of the picture.

“Adjusting the Color Balance (White Balance)” (p.58)

 - ▶ **MENU button** → [Rec. Mode 1] → [White Balance]

You can also adjust the sharpness, saturation, and contrast of the picture (p.60).

Selecting the Shooting Mode

By selecting the shooting mode according to the shooting situation, you can easily take pictures with the appropriate settings.

Select from Program, Night Scene, Landscape, Flower, Portrait, Surf & Snow, Sport, Pet, Food, and Frame Composite (p.42).

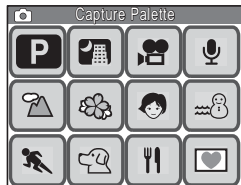

Selecting the shooting mode

- ▶ **Touch the LCD monitor** → [Capture Toolbar] → **P**.

Enjoy Recording Movies

With this camera, you can record movies (640×480 pixels at 30 fps), with sound for playback on a TV or PC, to an SD Memory Card or the built-in memory. Recorded movies can easily be edited with a variety of editing functions.

- You can also record movies at QVGA (320×240) size or at 15 fps.

1 Switch to Movie Recording Mode

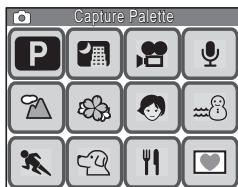

To record movies, use the [Capture Palette] to switch to Movie Recording mode.

Switching to Movie Recording mode

- ▶ In Capture mode, touch the LCD monitor → [Capture Toolbar] → **P** → double-touch **📷**.

2 Record a Movie



Press the shutter release button fully to start movie recording.

Press the shutter release button fully again to stop movie recording.

The information on the left appears on the LCD monitor during recording.

- ① Recording icon
- ② Remaining recordable time

3 Play Back the Movie



After recording a movie, press the  button to switch to Playback mode. The recorded movie appears on the LCD monitor.



In Playback mode, you can reverse playback, pause playback, adjust the volume, and reverse or forward playback frame by frame (p.82).

4 Edit a Movie



You can save one frame from a movie (p.107).

Selecting the movie editing method

▶ Touch the LCD monitor → [Playback Toolbar] →  → double-touch .

During Movie Recording:

Yes

- You can use both the optical and digital zoom when composing your shot, but only the digital zoom is available when shooting (p.45).
- You can record movies by pressing and holding the shutter release button for more than one second.
- You can adjust the recorded pixels, frame rate, and quality level (p.51).
- You can set the white balance, sharpness, saturation, and contrast (p.58, p.60).
- You can correct the exposure before recording (p.53).

No

- Flash mode and continuous shooting mode are not available.
- You cannot change the following shooting conditions:
 - [Focusing Area]: Spot (p.65)
 - [Focus Limiter]: Off (p.66)
 - [Aux.AF Light]: Off (p.66)
 - [AE Metering]: Center-weighted metering (p.55)
 - [Sensitivity]: Auto (p.67)

Enjoy Recording Sounds

You can record sounds to an SD Memory Card or the built-in memory. You can add an index during recording to help you quickly find the section of sound you want to listen to. You can also add voice memos to pictures you have taken.

2

1 Switch to Voice Recording Mode

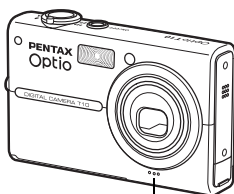

Microphone

To record sounds, use the [Capture Palette] to switch to Voice Recording mode.

Switching to Voice Recording mode

▶ In Capture mode, touch the LCD monitor → [Capture Toolbar] → → double-touch .

2 Record Sounds



Press the shutter release button fully to start voice recording. The self-timer lamp blinks during recording.

Press the shutter release button fully again to stop voice recording.

The following information appears on the LCD monitor during recording.

- ① Recording time
- ② Remaining recordable time

Using the Index Function for Quicker and Easier Playback

Touch [Index] on the LCD monitor during recording to add an index to the current sound file. By adding an index to a point in the sound file, you can quickly jump to that position during playback at any time.

- Indexes cannot be added during playback.

3 Play Back the Sound

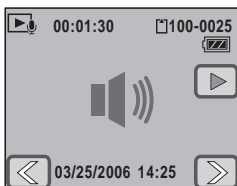

After recording, press the  button to switch to Playback mode.

In Playback mode, you can fast forward, fast rewind, and adjust the volume. When indexes are added during recording, you can fast forward or fast rewind to each index (p.83).

Adding a Voice Memo to a Picture

You can add a voice memo of up to 60 seconds to a picture you have already taken to describe the picture or how it was shot (p.105).

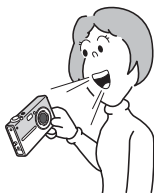

Enjoy Printing Images

After taking pictures and editing them, you can print them easily by using DPOF (Digital Print Order Format) settings. You can even print them directly from the camera without a PC when using a PictBridge-compatible printer. You can then share prints with friends and family or keep them in a photo album. Pictures can be output on a DPOF-compatible printer or printed by a local photo processing lab using DPOF settings that indicate the number of photos and date imprinting options for your “print order”.

1

Make the DPOF Print Settings

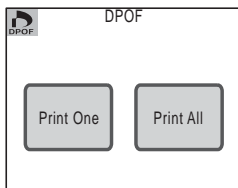

Choose the number of copies and if the date is to be superimposed on the pictures you want to print (DPOF settings) (p.110).

The pictures can then be printed using a DPOF-compatible printer or photo processing lab.

- To use a photo processing lab, take the SD Memory Card containing the pictures with the print order data and ask to have them printed.

How to configure the DPOF settings

- ▶ In **Playback mode**, touch the LCD monitor → [Playback Toolbar] → → double-touch .

2

Set the USB Connection Mode

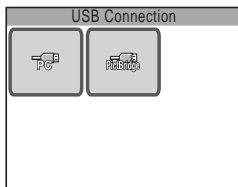

By connecting the camera to a PictBridge-compatible printer with the provided USB cable, you can print images directly from the camera without a PC.

To print pictures, you need to set the [USB Connection] mode on the camera to [PictBridge] in advance (p.130).

Setting the [USB Connection] mode

- ▶ **MENU button** → touch [Setting] → [USB Connection].

3 Connect the Camera to a Printer

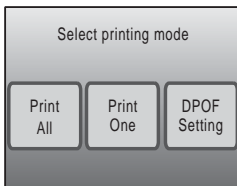

Connect the camera to a printer that supports PictBridge using the provided USB cable. The settings for the number of copies and whether to superimpose the date can also be made on the camera when printing even if no DPOF print settings are made (p.113).

4 Print the Images

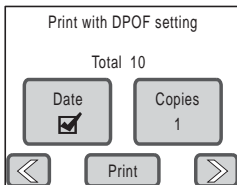

If the DPOF settings have already been made, simply touch [DPOF Setting] and then [Print] to print the pictures (p.116). You can also print individual images (p.114) or print all the images on an SD Memory Card or those stored in the built-in memory (p.116).

When printing is completed, turn off the camera, and disconnect the USB cable from the camera and printer.

Inserting the Date on Prints

By inserting the date on your prints, you can easily determine when the picture was taken. The setting for inserting the date can be made when making the DPOF settings or when printing (p.110, p.114, p.116).

- Not all printers are capable of date imprinting.



3 Taking Pictures

Setting the Shooting Functions

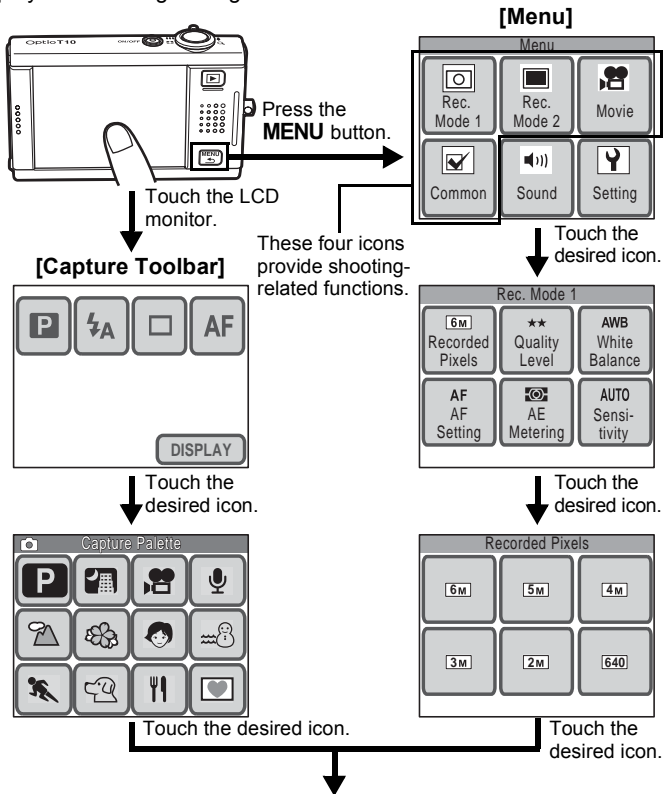

In Capture mode, press the **MENU** button or touch the LCD monitor to display the shooting settings.









Continue with operations while following the on-screen guidance.

- On the **[Capture Palette]**, touch an icon to display the guide display. To skip the guide display, double-touch the icon.
- If you press the shutter release button or no operation is performed for a certain period of time, the camera returns to Capture mode.
- Press the **[▶]** button to switch to Playback mode.
- Press the **MENU** button to return to the previous screen.

Functions set with the [Capture Toolbar]

Item	Description	Default Setting	Page
Shooting Mode	Sets the shooting mode according to the shooting condition or your subject.	 (Program)	p.42
Flash Mode	Sets the flash mode according to the shooting condition.	 (Auto)	p.56
Drive Mode	Sets the self-timer, continuous shooting mode, and remote control.	<input type="checkbox"/> (Standard)	p.69, p.70, p.72
Focus Mode	Sets the focus mode.	AF (Standard)	p.63
Information Display	Sets the type of information displayed on the LCD monitor.	Standard	p.40

Functions set with the [Menu]

	Item	Description	Default Setting	Page	
☐ Rec. Mode 1	Recorded Pixels	Sets the number of recorded pixels of pictures.	 (2816×2112)	p.49	
	Quality Level	Sets the quality level of pictures.	★★ (Better)	p.49	
	White Balance	Adjusts the color balance according to the light conditions.	AWB (Auto)	p.58	
	AF Setting	Focusing Area	Chooses the focusing area.	 (Multiple)	p.65
		Focus Limiter	Limits the focus range.	On	p.66
		Aux.AF Light	For choosing whether to use the auxiliary AF light when shooting in dimly lit locations.	On	p.66
	AE Metering	For choosing which area of the image to measure for determining the exposure.	 (Multi-segment metering)	p.55	
Sensitivity	Sets the ISO sensitivity.	Auto	p.67		
■ Rec. Mode 2	EV Compensation	Adjusts the overall brightness of the picture.	±0.0	p.53	
	Instant Review	Sets the amount of time an image is displayed on the LCD monitor after a picture is taken.	1 sec.	p.73	
	Sharpness	For choosing sharp or soft outlines.	 (Normal)	p.60	
	Saturation	Adjusts the color saturation.	 (Normal)	p.60	
	Contrast	Adjusts the image contrast level.	 (Normal)	p.60	

	Item	Description	Default Setting	Page
Movie	Recorded Pixels	Sets the number of recorded pixels for movies.	640 (640×480)	p.51
	Quality Level	Sets the quality level of movies.	★★★ (Best)	p.51
	Frame Rate	Sets the frame rate (number of frames per second).	30fps	p.51
Common	Digital Zoom	Activates the digital zoom function.	On	p.46
	Memory	Retains your shooting settings or returns to the default values when the camera is turned off.	On (only for Flash mode, Digital Zoom, and File #)	p.38
	Fn Setting	For quickly calling up frequently used functions.	OFF Off	p.36

3

Taking Pictures

Calling Up Frequently Used Functions

Up to four frequently used functions can be assigned to the [Capture Toolbar] for easy access when taking pictures or recording movies.



Assigned functions

Functions that can be called up when taking pictures and recording movies

	Item	When Taking Pictures	When Recording Movies
Rec. Mode 1	Recorded Pixels	○	○
	Quality Level	○	○
	Frame Rate	—	○
	White Balance	○	○
	Focusing Area	○	×
	Focus Limiter	○	×
	AE Metering	○	×
Rec. Mode 2	Sensitivity	○	×
	EV Compensation	○	○
	Sharpness	○	○
	Saturation	○	○
	Contrast	○	○

Assigning a Function to the Capture Toolbar

1 Press the MENU button.

The [Menu] appears.

2 Touch [Common].

The Common screen appears.

3 Touch [Fn Setting].

The Fn Setting screen appears.

4 Touch the OFF icon you want to assign a function to in the [Capture Toolbar].

To assign a function to call up when taking pictures, touch the OFF icon under .

To assign a function to call up when recording movies, touch the OFF icon under .

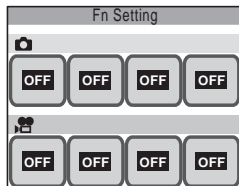

5 Touch the icon of the function you want to assign to the [Capture Toolbar].

- The setting is saved and the screen returns to the previous screen.
- If the function you want to assign does not appear, touch [

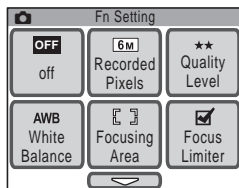

6 Repeat Steps 4 to 5 to assign the necessary functions.

7 Press the MENU button three times.

- The camera returns to Capture mode.
- Press the  button to return to Playback mode.



Memo

To cancel a function assigned to the [Capture Toolbar], touch the OFF (Off) icon in Step 5.

Saving the Current Camera Settings

You can choose to have the camera save the following function settings when it is turned off. By using [Memory] in the Memory screen, you will not need to select the same settings again when shooting under similar conditions.

All other shooting-related functions not listed below are saved even if the camera is turned off.

Item	Descriptions	Default Setting
Flash Mode	The selected flash mode other than $\frac{1}{2}$ (Auto) is saved.	<input checked="" type="checkbox"/>
Drive Mode	The selected drive mode setting ([Self-timer], [Cont. Shooting], or [Remote Control]) is saved.	<input type="checkbox"/>
Focus Modes	The selected focus mode other than AF (Standard) is saved.	<input type="checkbox"/>
Zoom Position	The optical zoom position set with the zoom lever is saved.	<input type="checkbox"/>
MF Position	The focusing distance chosen with manual focus is saved.	<input type="checkbox"/>
White Balance	The selected white balance setting other than AWB (Auto) is saved.	<input type="checkbox"/>
AE Metering	The selected AE metering setting other than  (Multi-segment metering) is saved.	<input type="checkbox"/>
Sensitivity	The selected ISO sensitivity setting other than Auto is saved.	<input type="checkbox"/>
EV Compensation	An exposure setting other than ± 0.0 is saved.	<input type="checkbox"/>
Digital Zoom	The digital zoom setting (On/Off) is saved.	<input checked="" type="checkbox"/>
DISPLAY	The LCD monitor display setting is saved.	<input type="checkbox"/>
File #	The file number is saved. If a new SD Memory Card is inserted, file numbers are assigned sequentially.	<input checked="" type="checkbox"/>

- If you select (On), the settings are saved even if the camera is turned off. If you select (Off), the settings are reset to the defaults when the camera is turned off.
- A zoom position in the digital zoom range cannot be saved even when [Zoom Position] is set to On in [Memory].

1 Press the MENU button.

The [Menu] appears.

2 Touch [Common].

The Common screen appears.

3 Touch [Memory].

The Memory screen appears.

4 Touch the setting you want to change.

- The setting changes to (On) or (Off).
- If the function you want to change does not appear, touch [] to advance the screen.

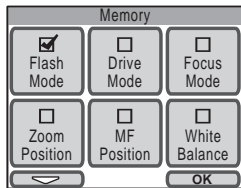
**5 Touch [OK].****6 Press the MENU button twice.**

- The camera returns to Capture mode.
- Press the button to return to Playback mode.

Displaying Shooting Information in Capture Mode

You can choose from the following four display modes when in Capture mode. Refer to “Monitor Indications” on the inside of the front cover for details of each display mode.

[Standard]



[Standard+Histogram]

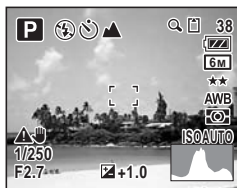

[No info. Display]



[LCD Off]



Memo

- All buttons are operable even if the display mode is set to [LCD Off]. For example, pressing the shutter release button allows you to take pictures.
- appears when camera shake is likely to occur. Refer to p.62 for information on how to prevent camera shake.
- The shape of the histogram gives you information about the brightness and contrast of your picture (p.54).
- When firing the flash, (Flash icon) appears even if the display mode is set to [No info. Display].

1 In Capture mode, touch the LCD monitor.

The [Capture Toolbar] appears.

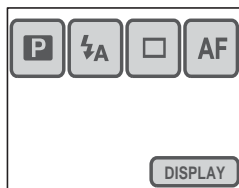

2 Touch [DISPLAY].

The DISPLAY Selection screen appears.

3 Touch the desired setting.



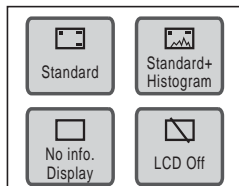







The setting is saved and the camera returns to Capture mode.









Selecting a Shooting Mode

Selecting the Shooting Mode in the Capture Palette

By selecting the shooting mode according to the shooting situation, you can easily take pictures with the appropriate settings. The shooting modes for taking pictures are as shown below.

Icon	Shooting Mode	Description	Functions Not Available
	Program	The camera automatically adjusts the shutter speed and aperture for taking still pictures. You can set other shooting functions such as the flash mode or continuous shooting mode.	None
	Night Scene	The camera decreases the shutter speed for beautiful pictures of night views. To prevent camera shake, use a tripod or rest the camera on a flat surface when taking pictures with this mode. Use the flash if people are included (p.44).	
	Landscape	The camera sets the focus to keep both near and far objects as sharp as possible.	White Balance, Sharpness, Saturation, Contrast
	Flower	Flowers are captured with soft outlines.	
	Portrait	Gives your subject a bright, natural look.	
	Surf & Snow	For taking pictures under extremely bright conditions such as beach and snow scenes.	
	Sport	The camera increases the shutter speed to make it easier to capture fast-moving subjects without blurring.	
	Pet	The camera takes into account the color of the pet's fur for proper exposure (p.44).	
	Food	The camera increases the saturation for bright, vivid pictures of food.	
	Frame Composite	For shooting composite images using picture frames stored in the camera (p.47).	Cont. Shooting, Recorded Pixels

Memo

- When Shooting mode is set to  (Sport) or  (Pet), [Flash Mode] is set to  (Flash Off). However, the flash mode can be changed.
- When Shooting mode is set to  (Flower), [Focus limiter] is set to Off, but the setting can be changed.
- When Shooting mode is set to  (Frame Composite), the number of recorded pixels is fixed at  and cannot be changed.

1 In Capture mode, touch the LCD monitor.



The [Capture Toolbar] appears.

2 Touch the  (Shooting Mode) icon.

- The icon of the currently selected shooting mode appears in place of the  icon.
- The [Capture Palette] appears.

**3 Touch the desired shooting mode icon.**

A guide display of the selected shooting mode appears.

- To skip the guide display, double-touch the icon. The shooting mode is selected and the camera returns to Capture mode.
- Touch the arrow icons ( ) to advance to other shooting modes.
- Touch [Palette] to return to the [Capture Palette].

4 Touch [OK].

The shooting mode is selected and the camera returns to Capture mode.

5 Press the shutter release button halfway.

The focus frame on the LCD monitor turns green if the subject is in focus.

6 Press the shutter release button fully.

The picture is taken.

Memo

You can set the display not to show the guide by default (p.135).

Taking Pictures in Dimly Lit Locations

When taking pictures under low light conditions, such as during twilight or at night, the camera shutter must be opened longer to allow more light in. This camera comes with a special mode  (Night Scene) for taking pictures when light levels are low. In Night Scene mode, the camera decreases the shutter speed for optimal exposure to capture beautiful pictures at night. You can also use this mode to take portraits with night scenes in the background as the camera will automatically select a long shutter speed even when using the flash.

3

Taking Pictures



Memo

- When pictures are taken in dimly lit locations, the shutter must stay open longer which contributes to camera shake. When using a shutter speed at which camera shake is likely to occur,  (camera shake warning) appears on the LCD monitor. To prevent camera shake, use a tripod and the self-timer or remote control function.
- You can also increase the ISO sensitivity setting to take pictures in dimly lit locations without using the flash. When the sensitivity is increased, the shutter speed also increases, making it easier to prevent camera shake and blurring of the subject. However, noise, which appears as a grainy pattern, may appear in the picture (p.67).

Taking Pictures of Your Pet

In Pet mode () , choose the appropriate icon depending on whether your pet is dark, light, or in between. The exposure will automatically be adjusted to produce the best picture. Choosing either the cat or dog icon does not affect the resulting picture. Choose whichever you prefer.





Composing Your Shot

Using the Zoom

When the zoom is set to a wide angle, more of the scene is included. When the zoom is set to telephoto, distant objects appear closer. Wide angle settings make near-to-far objects look further apart than they really are while telephoto settings make them look closer together.

1 In Capture mode, turn the zoom lever toward or .

 Tele : Brings the subject closer with a narrow angle of view.

 Wide : Makes the subject smaller with a wider angle of view.

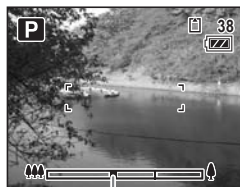

Zoom bar

Turn the zoom lever toward .

You can take pictures at up to three times magnification using the optical zoom. When the digital zoom is on, you can combine it with the optical zoom to enlarge the subject to a maximum magnification equivalent to 12 times.



Optical zoom range Digital zoom range

Caution

You cannot use the optical zoom when the focus mode is set to  (Macro). Only the digital zoom is available.

Memo

- Camera shake is likely to occur when taking pictures at telephoto settings. To prevent camera shake, use a tripod and the self-timer or remote control function.
- Using the digital zoom produces a slightly grainy image. For the best image quality, use optical zoom.

Setting the Digital Zoom

[Digital Zoom] is set to On in the default settings. To take pictures using only the optical zoom, set [Digital Zoom] to Off.

1 Press the MENU button.

The [Menu] appears.

2 Touch [Common].

The Common screen appears.

3 Touch [Digital Zoom].

The setting changes to (On) or (Off).

4 Press the MENU button twice.

- The camera returns to Capture mode.
- Press the  button to return to Playback mode.

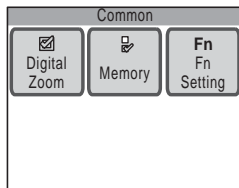

Taking Pictures with the Built-in Photo Frames

You can take pictures using any of the seven decorative frames stored in the camera.

1 In Capture mode, touch the LCD monitor.

The [Capture Toolbar] appears.

2 Touch the **P** (Shooting Mode) icon.

- The icon of the currently selected shooting mode appears in place of the **P** icon.
- The [Capture Palette] appears.

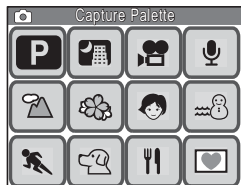

3 Double-touch the **♥** icon.

- The Frame Selection screen appears.
- To bring up the guide display, single-touch the icon.

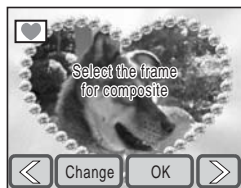

4 Touch the arrow icons (**◀ ▶**) to choose the frame you want to use, and touch [OK].

- The setting is saved and the camera returns to Capture mode.

5 Press the shutter release button halfway.

The focus frame on the LCD monitor turns green if the subject is in focus.

6 Press the shutter release button fully.

The picture is taken.



Memo

- The frames used in this function are stored in the camera's built-in memory. They can be replaced with different frames that can be copied from an SD Memory Card by touching [Change] on the Frame Selection screen (p.100).
- The number of recorded pixels is fixed at **3M**.
- If the number of recorded pixels is other than **3M** before using this function and you change the shooting mode, the setting for the image size returns to the previous value.

Adjusting the Size, Quality Level, Brightness, and Color Tone

The camera will automatically adjust settings such as brightness and color tone to capture pictures and movies as optimally as possible. If, however, you want to use creative effects, you will need to customize the shooting functions. This section explains the various built-in functions that can help you to capture better pictures and movies.

Size and Quality Level

Set the size and quality level according to how you intend to use the pictures or movies (p.49).

Brightness

The brightness (exposure) of a picture is determined by the amount of light entering the camera lens (aperture) and the length of time the light is allowed to enter (shutter speed). If the brightness of a picture is not at the desired level, one solution is to adjust the setting using the EV compensation function (p.53). The AE metering function is also helpful in allowing you to select the metering method to measure proper brightness under different shooting situations (p.55).

When you take a picture in a dimly lit location, using the flash to illuminate the subject is a basic technique (p.56). But if you want a more natural feeling and do not want to use the flash, customizing the ISO sensitivity (p.67) can help produce a properly exposed image.

Color Balance (White Balance)

Use the white balance setting if the color balance of the image is not pleasing, or if you want to give the picture a bluish or reddish look (p.58).

Sharpness, Saturation, and Contrast

Sharpness, saturation and contrast settings are available in three levels (p.60) for sharpening or softening the outlines of an image, enhancing its vividness, and adjusting the image contrast.

Setting the Recorded Pixels, Quality Level, and Frame Rate

You can set the number of recorded pixels (width × height) and quality level (data compression rate) for pictures and movies, and the frame rate (number of frames per second) for movies, according to how you intend to use the pictures or movies.

The larger the number of recorded pixels and quality level (indicated by the number of stars (★)), the clearer the details will appear when you print your picture or play back a movie. Similarly, the larger the frame rate, the smoother the movement will appear in movies. However, these increase the file size of pictures or movies, thereby reducing the number of pictures that can be stored in memory or the recording time for movies.

Set the [Recorded Pixels], [Quality Level], and [Frame Rate] settings according to how you intend to use your pictures and movies.

For Pictures

Appropriate Number of Recorded Pixels According to Use

6M	2816 × 2112	↑ Clearer and more detailed	For printing high quality photos or A4-size pictures or larger, or editing images on a PC.
5M	2592 × 1944		
4M	2304 × 1728		
3M	2048 × 1536		
2M	1600 × 1200		For making postcard-size prints.
640	640 × 480		For posting on a website or attaching to e-mail.

Appropriate Quality Level According to Use

★★★ (Best)	Lowest compression rate. Suitable for printing A4-size pictures or larger.
★★ (Better)	Standard compression rate. Suitable for printing 3.5"×5" pictures and viewing the images on a computer screen.
★ (Good)	Highest compression rate. Suitable for posting on a website or attaching to e-mail.

1 Press the MENU button.

The [Menu] appears.

2 Touch [Rec. Mode 1].

The Rec. Mode 1 screen appears.

3 Touch [Recorded Pixels].

The Recorded Pixels screen appears.

4 Touch the desired recorded pixels.

The setting is saved and the screen returns to the previous screen.

5 Press the MENU button twice.

- The camera returns to Capture mode.
- Press the  button to return to Playback mode.

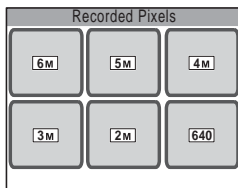
**Setting the Quality Level**

In Step 3, touch [Quality Level] and select the desired quality.

**3****Taking Pictures****Memo**

- When Shooting mode is set to  (Frame Composite), the number of recorded pixels is fixed at **3M** and cannot be changed.
- The quality of prints also depends on the resolution of your printer.

Recorded Pixels, Quality Level and Approx. Image Storage Capacity

	★★★ (Best)		★★ (Better)		★ (Good)	
	Built-in Memory	128 MB	Built-in Memory	128 MB	Built-in Memory	128 MB
6M 2816 × 2112	3 pictures	35 pictures	7 pictures	73 pictures	10 pictures	103 pictures
5M 2592 × 1944	4 pictures	42 pictures	8 pictures	82 pictures	12 pictures	124 pictures
4M 2304 × 1728	5 pictures	53 pictures	10 pictures	103 pictures	15 pictures	155 pictures
3M 2048 × 1536	6 pictures	68 pictures	12 pictures	130 pictures	18 pictures	190 pictures
2M 1600 × 1200	10 pictures	103 pictures	17 pictures	177 pictures	26 pictures	275 pictures
640 640 × 480	39 pictures	414 pictures	66 pictures	690 pictures	92 pictures	966 pictures

- The above figures may vary depending on the subject, shooting conditions, shooting mode and capacity of the SD Memory Card, etc.

For Movies

Appropriate Number of Recorded Pixels According to Use

640 640×480	Suitable for viewing the movie on a TV or PC.
320 320×240	Suitable for posting on a website or attaching to e-mail.

Appropriate Quality Level According to Use

★★★ (Best)	↑ ↓	Clearer and more detailed images
★★ (Better)		Grainier images
★ (Good)		

Appropriate Frame Rate According to Use

30fps	Smoother transition
15fps	Longer recording time

1 Press the MENU button.

The [Menu] appears.

2 Touch [Movie].

The Movie screen appears.

3 Touch [Recorded Pixels].

The Recorded Pixels screen appears.

4 Touch the desired recorded pixels.

The setting is saved and the screen returns to the previous screen.

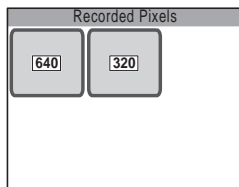

5 Press the MENU button twice.

- The camera returns to Capture mode.
- Press the  button to return to Playback mode.

Setting the Quality Level and Frame Rate

In Step 3, touch [Quality Level] or [Frame Rate] and select the desired setting.

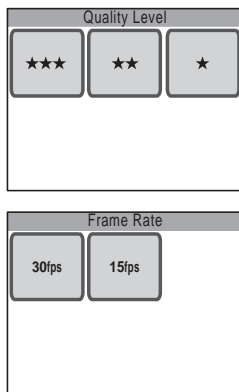

3

Taking Pictures

Recorded Pixels, Quality Level, Frame Rate and Approx. Recording Time

		30fps		15fps	
		Built-in Memory	128 MB	Built-in Memory	128 MB
640 640×480	★★★	4 sec.	48 sec.	9 sec.	1 min. 36 sec.
	★★	6 sec.	1 min. 9 sec.	13 sec.	2 min. 17 sec.
	★	10 sec.	1 min. 50 sec.	21 sec.	3 min. 40 sec.
320 320×240	★★★	18 sec.	3 min. 12 sec.	36 sec.	6 min. 24 sec.
	★★	26 sec.	4 min. 35 sec.	52 sec.	9 min. 7 sec.
	★	42 sec.	7 min. 19 sec.	1 min. 23 sec.	14 min. 32 sec.

- The above figures may vary depending on the subject, shooting conditions, shooting mode and capacity of the SD Memory Card, etc.

Setting the Exposure (EV Compensation)

You can adjust the overall brightness of the picture.

1 Press the MENU button.

The [Menu] appears.



2 Touch [Rec. Mode 2].

The Rec. Mode 2 screen appears.

3 Touch [EV Compensation].

The EV Compensation screen appears.

4 Touch the or icon to adjust the EV setting.

- To brighten, touch the  icon. To darken, touch the  icon. You can choose the EV setting in the range of -2.0 EV to +2.0 EV in 1/3 EV steps.
- You can also drag the cursor on the EV Compensation bar to the desired setting.
- The histogram is a graph that shows the brightness distribution of an image (p.54).

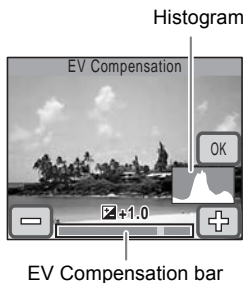

5 Touch [OK].



The setting is saved and the screen returns to the previous screen.

6 Press the MENU button twice.

- The camera returns to Capture mode.
- Press the  button to return to Playback mode.



Memo

The camera adjusts the proper exposure for the subject based on a neutral gray subject. Therefore, if you take a picture of a snowy scene or a black piano, for example, the subject may appear gray. To make black objects appear black, adjust the EV setting toward , and to make white objects appear white, adjust it toward .

Using the Histogram

This camera has a function for displaying a graph (histogram) that shows the tonal range of your scene with the darkest areas on the left and the brightest ones to the right. The height of the points along the graph show the number of pixels at each brightness value.

The shape of the histogram, which can be viewed before and after shooting, shows the brightness and contrast of the picture so you can decide if you want to use EV compensation to improve it.

☞ “Displaying Shooting Information in Capture Mode” (p.40), “Displaying Shooting Information” (p.76)

3

Taking Pictures

Understanding Brightness

Usually, if the exposure is correct, the graph peaks in the middle. If the image is too dark, the peak is on the left side, and if it is too bright, the peak is on the right side.

Dark image

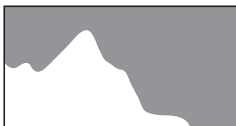

Correct image

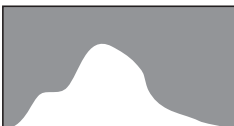

Bright image

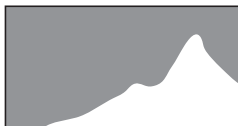

When the image is too dark, the part to the left is cut off (dark portions) and when the image is too bright, the part to the right is cut off (bright portions).

With EV compensation, you can adjust the exposure so that the distribution is contained within the graph without the graph peaking on the left or right side, thereby preventing pictures that are too dark or too light.

Understanding Contrast



The graph peaks gradually for images in which contrast is balanced. The graph peaks on both sides but sinks in the middle for images with a large difference in contrast and low amounts of mid-level brightness.



Selecting the AE Metering

You can choose which area of the image to measure for determining the exposure (brightness).

AE Metering

	Multi-segment metering	The camera takes a detailed reading of the overall brightness of the picture and determines the correct exposure. The camera can obtain a relatively correct exposure even for complex subjects with both dark and light areas.
	Center-weighted metering	The camera takes a uniform reading of the overall brightness of the picture with the metering focused at the center of the image. You can take pictures with the correct exposure for subjects at the center of the picture even if the surrounding background is lighter or darker than the subject.
	Spot AE metering	The camera determines the exposure by metering only the objects in the center spot. Use this to obtain correct exposure on a small part of the image.

1 Press the **MENU** button.

The [Menu] appears.

2 Touch [Rec. Mode 1].

The Rec. Mode 1 screen appears.

3 Touch [AE Metering].

The AE Metering appears.

4 Touch the desired AE metering method.

The setting is saved and the screen returns to the previous screen.

5 Press the **MENU** button twice.

- The camera returns to Capture mode.
- Press the  button to return to Playback mode.

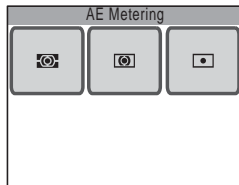

Memo

- When the shutter release button is pressed halfway, the camera meters the brightness and determines the exposure.
- When the subject is outside the focusing area and you want to use spot AE metering, aim the camera at the subject and press the shutter release button halfway to lock the exposure, then compose your picture again and press the shutter release button fully.
- When the shooting mode is set to  (Movie), the AE metering is fixed at Center-weighted metering and cannot be changed.

Using the Flash

Flash Mode

	Auto	The flash discharges automatically depending on the light conditions.
	Flash Off	The flash will not discharge.
	Flash On	The flash discharges each time a picture is taken.
	Auto + Red-eye	This mode reduces the phenomenon of red eyes caused by the light from the flash being reflected in the subject's eyes. The flash discharges automatically depending on the light conditions.
	Flash On + Red-eye	This mode reduces the phenomenon of red eyes caused by the light from the flash being reflected in the subject's eyes. The flash will discharge regardless of the light conditions.
	Soft	This mode reduces the intensity of the flash so that the flash is not too bright when fired at close range. The flash will discharge regardless of the light conditions.

1 In Capture mode, touch the LCD monitor.

The [Capture Toolbar] appears.

2 Touch the (Flash Mode) icon.

- The icon of the currently selected flash mode appears in place of the icon.
- The Flash Mode screen appears.





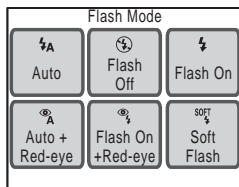



3 Touch the desired flash mode.

- The setting is saved and the camera returns to Capture mode.
- Press the button to return to Playback mode.







Memo

- The approximate range of the flash is 0.15 m to 4.5 m when not using the 3× optical zoom (wide-angle setting) and 0.4 m to 2.5 m when using the 3× optical zoom (telephoto setting). If the subject is too far from the camera, it will not be illuminated by the flash. Additionally, if the subject is too close to the camera, exposure will not be correctly adjusted. Increase the sensitivity (p.67) to extend the effective range of the flash.
- You can also increase the ISO sensitivity setting to take pictures in dimly lit locations without using the flash. When the sensitivity is increased, the shutter speed also increases, making it easier to prevent camera shake and blurring of the subject. However, you may notice increased noise, which looks like a grainy pattern, in the picture (p.67).

- The flash mode is fixed at  (Flash Off) when the shooting mode is set to  (Movie), the drive mode is set to  (Cont. Shooting), or the focus mode is set to .
- Taking pictures using the flash in dark locations may cause the subject's eyes to appear red in the resulting picture. This phenomenon occurs when the light from the flash is reflected in the subject's eyes. Setting the flash mode to  (Auto + Red-eye) or  (Flash On + Red-eye) is an effective way of preventing red eyes. It can be also reduced by illuminating the area around the subject or moving closer to the subject and zooming out. If the subject's eyes still appear red despite such precautions, they can be corrected by the red-eye compensation function later (p.104).
- Pre-flashes discharge when the flash mode is set to  (Auto + Red-eye) or  (Flash On + Red-eye).

Adjusting the Color Balance (White Balance)

White balance is a function for adjusting the color of an image so that white objects appear white. If the automatic camera settings do not provide the desired color balance, or if you want to make pictures more bluish or reddish, you can adjust the White Balance setting.

AWB	Auto	The camera automatically adjusts the color balance.
	Daylight	Use this mode when taking pictures outside in sunlight.
	Shade	Use this mode when taking pictures outside in the shade. It reduces the bluish color tones in a picture.
	Tungsten Light	Use this mode when taking pictures under electric or other tungsten light. It reduces the reddish color tones in a picture.
	Fluores. Light	Use this mode when taking pictures under fluorescent light.
	Manual	Use this to manually adjust the white balance according to the lighting so that white objects appear as a natural white.

1 Press the MENU button.

The [Menu] appears.

2 Touch [Rec. Mode 1].

The Rec. Mode 1 screen appears.

3 Touch [White Balance].

The White Balance screen appears.

4 Touch the arrow icons (◀ ▶) to choose the white balance.

5 Touch [OK].

The setting is saved and the screen returns to the previous screen.



6 Press the MENU button twice.

- The camera returns to Capture mode.
- Press the  button to return to Playback mode.



Memo

Using the white balance  (Shade) when taking pictures of sunsets and sunrises emphasizes their reddish tones.

Adjusting the White Balance Manually (Manual)

Have a blank sheet of white paper or similar material ready.

1 Select [Manual] on the White Balance screen.

[Adj.] and the adjustment frame appear.

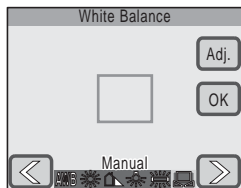

2 Point the camera at the blank sheet of paper or other material so that it fills the middle of the adjustment frame.

3 Touch [Adj.].

The white balance is adjusted, and [Complete] appears when adjusting is finished.

4 Touch [OK].

The setting is saved and the screen returns to the previous screen.

5 Press the MENU button twice.

- The camera returns to Capture mode.
- Press the  button to return to Playback mode.



Memo

When you touch [OK] before pressing [Adj.], the previously adjusted white balance value is retained even if  (Manual) is adjusted.

Adjusting the Sharpness, Saturation, and Contrast

Sharpness, saturation, and contrast each have three levels of adjustment available for sharpening or softening image outlines, enhancing vividness, and adjusting image contrast.

1 Press the MENU button.

The [Menu] appears.

2 Touch [Rec. Mode 2].

The Rec. Mode 2 screen appears.

3 Touch [Sharpness].

The Sharpness screen appears.

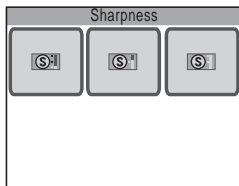

4 Touch the level of sharpness.

- Select [Soft] (Soft), [Normal] (Normal), or [Hard] (Hard).
- The setting is saved and the screen returns to the previous screen.

5 Press the MENU button twice.

- The camera returns to Capture mode.
- Press the [Play] button to return to Playback mode.

Setting the Saturation and Contrast

In Step 3, touch [Saturation] or [Contrast].

Select [Low] (Low), [Normal] (Normal), or [High] (High) for the saturation, and [Low] (Low), [Normal] (Normal), or [High] (High) for the contrast.

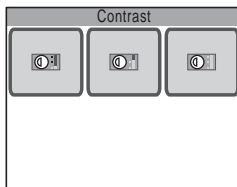
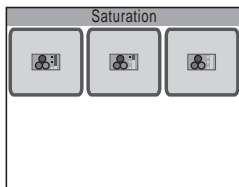

Focusing

The camera automatically focuses on your subject when you press the shutter release button halfway. If, however, you want to quickly focus on a specific point, you will need to select one of the camera's focus modes. This section explains the various focusing settings.

Choosing the Focusing Range

By default, the camera automatically focuses on subjects within a range of approximately 40 cm to infinity. By setting the [Focus Limiter] (p.66) to Off, you can focus on subjects within a range of approximately 15 cm to infinity.

Set the focus mode when you want to quickly focus on close or distant objects, when you want to keep everything on the screen in focus, or when you want to focus manually (p.63).

Choosing the Focusing Area

By default, the camera focuses on the closest object in the middle of the focus frame. Select another focusing option if you want the camera to focus on a different point (p.65).

Subjects Difficult to Focus On

The camera may not be able to focus under the following conditions. In this case, lock the focus on an object the same distance away as the subject (by pressing the shutter release button halfway), then aim the camera at your subject and press the shutter release button fully.

- Objects that lack contrast such as a blue sky or white wall
- Dark places or objects, or conditions that prevent light being reflected back
- Horizontal lines or intricate patterns
- Fast moving objects
- When there is an object in the foreground and an object in the background in the same picture
- Strongly reflected light or strong backlighting (bright background)

Focusing in Dimly Lit Locations

By default, the camera is set to use the auxiliary AF light for easier focusing in dimly lit locations (p.66).

Preventing Camera Shake and Blurring of the Subject



There are several solutions to prevent inadvertent camera movement (camera shake) and blurring of the subject. Increasing the ISO sensitivity (p.67) or using the flash (p.56) is one solution as the camera then takes pictures at higher shutter speeds. Higher shutter speeds are effective for preventing both camera shake and blurring of the subject.

You can check if camera shake is likely to occur when  (camera shake warning) appears on the LCD monitor. Using a tripod and the self-timer (p.69) or remote control function (p.70) is recommended especially when camera shake is likely to occur.

Changing the Depth of Field

By zooming in on your subject from a close distance, you can narrow the depth of field and create a blurred background (p.45).

Selecting the Focus Mode

AF	Standard	Use this mode when the distance to the subject is 40 cm (16 in.) or more. The camera focuses on the subject in the focusing area when the shutter release button is pressed halfway.
	Macro	Use this mode when the distance to the subject is approximately 15 cm (6 in.) to 40 cm (16 in.). The camera focuses on the subject in the focusing area when the shutter release button is pressed halfway.
PF	Pan Focus	This mode is used when you want everything from near to far to be in focus. Use it when asking someone to take your picture or when taking pictures of scenery through the window of a moving car or train.
	Infinity	This mode is used for taking pictures of distant objects. The flash is fixed at  (Flash Off) and the focus position is fixed at Infinity.
MF	Manual Focus	This mode lets you adjust the focus manually.

3

1 In Capture mode, touch the LCD monitor.

The [Capture Toolbar] appears.

2 Touch the **AF (Focus Mode)** icon.

- The icon of the currently selected focus mode appears in place of the **AF** icon.
- The Focus Mode screen appears.

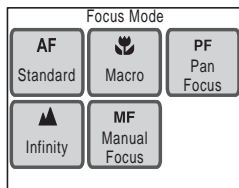

3 Touch the desired focus mode.

- The setting is saved and the camera returns to Capture mode.
- Press the  button to return to Playback mode.

Caution

You cannot use the optical zoom when the focus mode is set to  (Macro). Only the digital zoom is available.

Memo

- If focusing is not possible with **AF** (Standard), the camera operates as follows.
 - When the flash is fired or [White Balance] is set to [Fluores. Light] or [Tungsten Light], the camera focuses at a distance of 2 m (6.6 ft.).
 - In all other situations, the focus mode is automatically switched to [Pan Focus].
- If focusing is not possible with  (Macro), pictures cannot be taken.

Adjusting the Focus Manually

1 Touch [Manual Focus] on the Focus Mode screen.

The Adjustable MF guide appears on the LCD monitor.



2 Touch a point inside the Adjustable MF guide.

The area inside the Adjustable MF guide is enlarged to fill the screen.



MF bar

3 Touch the arrow icons (◀ ▶) to adjust the focus.

The MF bar appears on the LCD monitor to indicate the approximate manual focus position. Use this to adjust the focus.

◀: For closer focus

▶: For distant focus

4 Press the shutter release button halfway.

- The camera returns to Capture mode.
- Press the ▶ button to return to Playback mode.





Memo

The camera returns to Capture mode and the picture can be taken five seconds after you release your finger from either arrow icon (◀ or ▶).

Setting the Autofocus Conditions

Choosing the Focusing Area

	Multiple	Measures a wide range in the center portion within the focusing area and focuses on the nearest object.
	Spot	Measures narrower range in the focusing area.

1 Press the MENU button.

The [Menu] appears.

2 Touch [Rec. Mode 1].

The Rec. Mode 1 screen appears.

3 Touch AF.

The AF Setting screen appears.

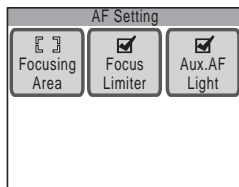

4 Touch [Focusing Area].

The Focusing Area screen appears.

5 Touch the focusing area you want to set.

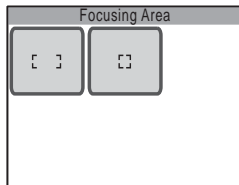

The setting is saved and the screen returns to the previous screen.



6 Press the MENU button three times.

- The camera returns to Capture mode.
- Press the  button to return to Playback mode.

Memo

When the shooting mode is set to  (Movie), the focusing area is fixed at  (Spot) and cannot be changed.

Limiting the Focus Range (Focus Limiter)

<input checked="" type="checkbox"/>	On	Focuses on a subject within the range of approximately 40 cm (16 in.) to infinity.
<input type="checkbox"/>	Off	Focuses on a subject within the range of approximately 15 cm (6 in.) to infinity when the zoom is not used (wide-angle setting). Focuses on a subject within the range of approximately 40 cm (16 in.) to infinity when the zoom is used (telephoto setting).

1 Touch [Focus Limiter] on the AF Setting screen.

The setting changes to (On) or (Off).

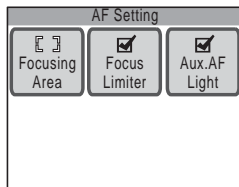

2 Press the MENU button three times.

- The camera returns to Capture mode.
- Press the button to return to Playback mode.



Memo

When Capture mode is set to (Flower), [Focus limiter] is set to Off, but you can change the setting.

Using the Auxiliary AF Light

<input checked="" type="checkbox"/>	On	When the autofocus does not work properly because the subject is in a dark location, the subject is illuminated with the auxiliary AF light (green light) to make it easier to focus on the subject.
<input type="checkbox"/>	Off	The auxiliary AF light is not activated even when the subject is too dark.

1 Touch [Aux.AF Light] on the AF Setting screen.

The setting changes to (On) or (Off).

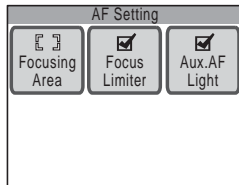



2 Press the MENU button three times.

- The camera returns to Capture mode.
- Press the button to return to Playback mode.

**Caution**

The auxiliary AF light of this camera conforms to the safety standard (IEC60825-1) for Class 1 LED products. Looking at the light directly will not create safety hazard. However, do not look into the emitter from a very short distance as it may make you dizzy.

**Memo**

The auxiliary AF light is not activated when the shooting mode is set to  (Movie), or the focus mode is set to **PF** (Pan Focus),  (Infinity), or **MF** (Manual Focus).

Setting the Sensitivity

You can select the sensitivity to suit the brightness of the surroundings.

Auto	The optimal value is automatically selected from 80, 160, or 320.
80	The lower the sensitivity, the less noise that affects the image. However the shutter speed will be slower in low light conditions.
160	
320	The higher the sensitivity, the faster the shutter speed becomes even in low light conditions. However, the image may have more noise (grainy effect).
400	

1 Press the MENU button.

The [Menu] appears.

2 Touch [Rec. Mode 1].

The Rec. Mode 1 screen appears.

3 Touch [Sensitivity].

The Sensitivity screen appears.

4 Touch the desired sensitivity.

The setting is saved and the screen returns to the previous screen.

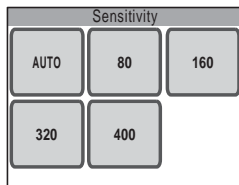
**5 Press the MENU button twice.**

- The camera returns to Capture mode.
- Press the  button to return to Playback mode.

**Memo**

When the shooting mode is set to  (Movie), the sensitivity is fixed at Auto and cannot be changed.

Taking Pictures

Instead of pressing the shutter release button on the camera, you can use the self-timer (p.69) or remote control function (p.70) to take pictures. You can also take continuous pictures (p.72) by keeping the shutter release button pressed.

The captured image appears on the LCD monitor for one second (Instant Review) and is saved.



The Instant Review time can be changed (p.73).



Using the Self-timer

In Self-timer mode, the picture is taken ten seconds or two seconds after the shutter release button is pressed.

Stabilize the camera with a tripod when taking a picture with the self-timer.

	This mode lets you be included in a group picture. The picture is taken about ten seconds after the shutter release button is pressed.
	This mode smoothly releases the shutter without shaking the camera. The picture is taken about two seconds after the shutter release button is pressed.





1 In Capture mode, touch the LCD monitor.

The [Capture Toolbar] appears.

2 Touch the (Drive Mode) icon.

- On the [Capture Toolbar], the icon of the currently selected [Drive Mode] appears in place of the  icon.
- The Drive Mode screen appears.

3 Touch the (self-timer mode) icon.

- On the Drive Mode screen, the icon of the currently selected self-timer mode appears in place of the  icon.
- The  and  icons appear on the LCD monitor.
- The self-timer options can be switched at any time by touching the  or  icon.



4 Press the shutter release button halfway.

The focus frame on the LCD monitor turns green if the subject is in focus.

5 Press the shutter release button fully.

A countdown of the time until the picture is taken appears on the LCD monitor, and the picture is taken ten seconds or two seconds after the shutter release button is pressed.



Memo

Pressing the shutter release button halfway during the countdown cancels the countdown. Press the shutter release button fully to restart the countdown.

Using the Remote Control

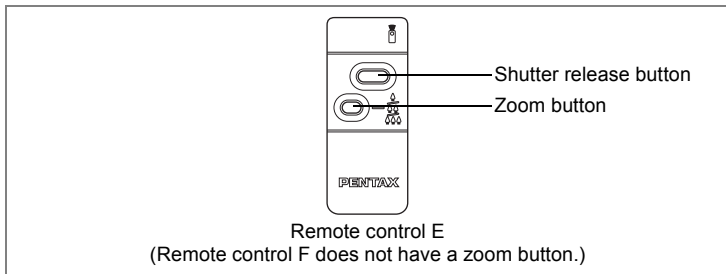

Instead of pressing the shutter release button, you can use the Remote control E or F (optional) to take pictures.





1 In Capture mode, touch the LCD monitor.

The [Capture Toolbar] appears.

2 Touch the □ (Drive Mode) icon.

- On the [Capture Toolbar], the icon of the currently selected [Drive Mode] appears in place of the □ icon.
- The Drive Mode screen appears.

3 Touch the (Remote Control) icon.

- On the Drive Mode screen, the icon of the currently selected remote control mode appears in place of the  icon.
- The  and  icons appear on the LCD monitor.
- The remote control options can be switched at any time by touching the  or  icon.
- The self-timer lamp blinks in remote control mode.

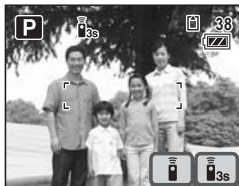

4 Press the shutter release button on the remote control.

: The self-timer lamp flashes quickly and the picture is taken after approximately three seconds.

: The picture is immediately taken.



Memo

To cancel recording in Movie Recording mode, press the shutter release button on the remote control or the camera.

Using the Remote Control to Adjust the Zoom Magnification

With the Remote control E (optional), you can also adjust the zoom magnification with the zoom button.

1 Press the zoom button on the remote control in remote control mode.

The zoom magnification changes each time the button is pressed.



Caution

- You cannot use the zoom button on the remote control when the focus mode is set to  (Macro).
- You can only use the zoom button on the remote control to adjust the zoom magnification within the optical zoom range. You cannot adjust the zoom magnification within the digital zoom range.



Memo

- All buttons on the camera are operable even when using the remote control function.
- The remote control can be operated up to approximately 4 m (13 ft.) from the front of the camera.
- With a new battery, the remote control can send signals to the camera approximately 30,000 times.

Taking Continuous Pictures

In this mode, pictures are taken continuously for as long as the shutter release button is pressed.

You can continue shooting until the memory capacity of the SD Memory Card or built-in memory is full.

1 In Capture mode, touch the LCD monitor.

The [Capture Toolbar] appears.

2 Touch the (Drive Mode) icon.

- On the [Capture Toolbar], the icon of the currently selected drive mode appears in place of the  icon.
- The Drive Mode screen appears.

3 Touch the icon.

The setting is saved and the camera returns to Capture mode.

4 Press the shutter release button halfway.

The focus frame on the LCD monitor turns green if the subject is in focus.

5 Press the shutter release button fully.

Pictures are taken continuously for as long as you keep the shutter release button pressed.



Caution

The flash will not discharge in Continuous Shooting mode.



Memo

- The interval of continuous shooting will vary according to the recorded pixels and quality level settings.
- The focus and exposure are locked with the first image.

Setting the Instant Review Time

You can choose the Instant Review time (the length of time the image is displayed immediately after a picture is taken) from [1sec], [2sec], [3sec], [4sec], [5sec] and [Off] (no display).

1 Press the MENU button.

The [Menu] appears.

2 Touch [Rec. Mode 2].

The Rec. Mode 2 screen appears.

3 Touch [Instant Review].

The Instant Review screen appears.

4 Touch the desired Instant Review time.

The setting is saved and the screen returns to the previous screen.

5 Press the MENU button twice.

- The camera returns to Capture mode.
- Press the  button to return to Playback mode.

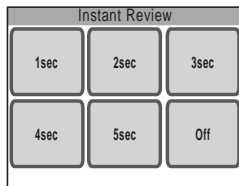

Setting the Playback Functions

Press the  button to switch from Capture mode to Playback mode. In Playback mode, you can use the [Playback Toolbar] to set the playback functions.

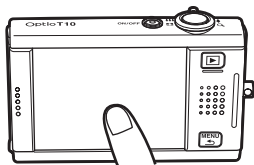

Touch the LCD monitor.

[Playback Toolbar]

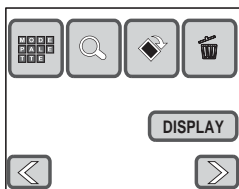

Touch the desired icon.

[Playback Palette]







Touch the desired icon.







Continue with operations while following the on-screen guidance.





- Touching an icon on the [Playback Palette], brings up the guide display. To skip the guide display, double-touch the icon.
- If you press the  button or no operation is performed for a certain period of time, the camera returns to Playback mode.
- Press the shutter release button (fully or halfway) to switch to Capture mode.
- Press the **MENU** button to return to the previous screen.

Functions Set with the [Playback Toolbar]

Item		Description	Default Setting	Page
	Playback Palette	The Playback Palette appears.	—	—
	Image Enlargement	Magnifies images.	—	p.79
	Image Rotation	Rotates images.	—	p.78
	Image Deletion	Deletes unwanted images.	—	p.88
DISPLAY	Information Display	Sets the type of information displayed on the LCD monitor.	Standard	p.76

Functions Available on the [Playback Palette]

Item		Description	Default Setting	Page
	Slideshow	Plays back recorded images and movies one after another.	3 sec, Wipe, On	p.84
	Resize	Changes the recorded pixels and quality level of an image and reduces the file size.	—	p.93
	Trimming	Crops out part of an image and saves it as a separate image.	—	p.94
	Image/Sound Copy	Copies images and sound files from the built-in memory to the SD Memory Card and vice versa.	—	p.108
	Special Effect	Color Filter	Uses black-and-white, sepia, red, blue, green, and other color filters to process an image.	B&W p.101
		Digital Filter	Softens images, makes them look like illustrations or makes the subject look broader or more slender.	Soft p.103
		Bright Filter	Makes images lighter or darker.	0 p.102
		Frame Composite	Adds a decorative frame to an image.	— p.99
		My Drawing	For drawing pictures on an image, adding stamps, creating a stamp from part of the image, and erasing part of the image.	— p.95
	Movie Edit (Save as Still Img)	Saves movie frames as still pictures.	—	p.107

Item		Description	Default Setting	Page
	Red-eye Compensation	Corrects images when the flash has caused the subject to appear with red eyes.	—	p.104
	Voice Memo	Adds a voice memo to images.	—	p.105
	Protect	Protects images and sound files from accidental deletion.	—	p.91
	DPOF	Inputs DPOF printing settings.	—	p.110
	Start-up Screen	Displays an image on the start-up screen.	—	p.106

Displaying Shooting Information

You can choose from the following three display modes when in Playback mode. Refer to “Monitor Indications” on the inside of the front cover for details of each display mode.

4

[Standard]



[Standard+Histogram]



[No info. Display]

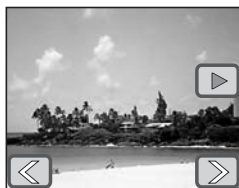

**Memo**

- With the histogram displayed, you can determine if the image was properly exposed (p.54).
- The histogram is not displayed for movie files.

1 In Playback mode, touch the LCD monitor.

The [Playback Toolbar] appears.

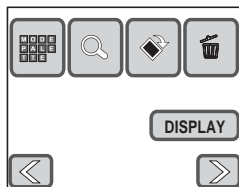
**2 Touch [DISPLAY].**

The DISPLAY Selection screen appears.

3 Touch the desired setting.

The setting is saved and the camera returns to Playback mode.

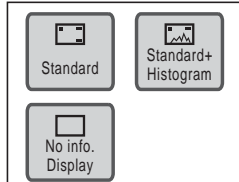

Playing Back Images, Movies, and Sound Files

Turning on the Camera in Playback Only Mode



Use this mode when you want to play back an image or sound file straightaway without taking pictures.

1 With your camera turned off, press the power switch while holding down the  button.



The camera turns on in Playback Only Mode. The lens remains retracted and does not extend.



Memo

- If you press the  button for more than two seconds in Capture mode, the camera switches to Playback Only mode and the lens is retracted.
- When you press the  button and release it within two seconds, the camera switches to normal Playback mode with the lens extended. When no operations have been performed more than 10 seconds in normal Playback mode or one of icons in the [Playback Palette] has been selected, the lens retracts automatically to prevent damage.
- If you press the  button in Playback Only mode, the camera switches to Capture mode and the lens is extended.

Rotating Images

1 In Playback mode, touch the arrow icons ( ) to choose the image you want to rotate.

2 Touch the LCD monitor.

The [Playback Toolbar] appears.

3 Touch the  icon.

The screen for selecting the direction of rotation appears.

4 Touch the direction you want to rotate the image.

The rotated image appears in full size.

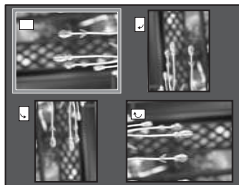

Caution

- Movies cannot be rotated.
- Protected images (p.91) and images on a write-protected SD Memory Card (p.19) cannot be rotated.



Magnifying Images

You can magnify an image up to 12 times. When an image is magnified, you can drag it to change the display location.

1 In Playback mode, touch the arrow icons (◀ ▶) to choose the image you want to magnify.

2 Turn the zoom lever toward 🔍.

The image is magnified (up to $\times 12$).

- You can also touch the  icon on the LCD monitor to magnify the image.
- Turn and hold the zoom lever toward 🔍 or touch and hold the  icon to increase the magnification.
- You can use the guide at the top left of the screen to check which portion of the image is magnified.







The following operations can be performed while the magnified image is displayed.

<Moving the magnified portion of the image>

- Drag and move the frame indicating the display area on the guide at the top left of the screen.
- Drag the displayed image in the direction you want to view.

<Changing the magnification>



- Turn the zoom lever toward 🔍 or touch the  icon to magnify the image (max. $\times 12$).
- Turn the zoom lever toward  or touch the  icon to demagnify the image (min. $\times 1$).
- Dragging your finger on the LCD monitor also enables you to enlarge an area of the image when it is displayed at $\times 1$ magnification.
- The image can be magnified to the maximum size ($\times 12$) by double-touching the  icon when it is displayed in basic size ($\times 1$).
- The image can be demagnified to the basic size ($\times 1$) by double-touching the  icon when it is displayed in maximum size ($\times 12$).

3 Press the MENU button.

The image returns to single-image display.



Caution

- Movies cannot be magnified.
- The guide for checking which portion of the image is magnified does not appear if the LCD monitor display mode is set to [No info. Display] (p.76). However, the   icons appear.

Nine-image Display

You can display nine captured images or sound files on the LCD monitor at a time.

1 In Playback mode, turn the zoom lever toward .

- Nine-image display appears.



The icons that appear on the thumbnails indicate the following:

No icon : Image without sound

 (with image) : Image with sound

 : Movie (first frame appears)

 (without image) : Sound-only file

- Touch the arrow icons ( ) to change the nine thumbnail images to another nine images.
- Touch the  icon to switch to the selection and deletion screen (p.90).



2 Touch a thumbnail in nine-image display.

The selected file is displayed in single-image display.

Playing Back an Image with a Voice Memo

- 1 In Playback mode, touch the arrow icons (◀ ▶) to choose an image with a voice memo (p.105).

The [] icon appears for images with a voice memo.



- 2 Touch the ▶ icon.

Playback of the voice memo starts.

The following operations can be performed during playback.

- Zoom lever (▲) : Increases the volume
- Zoom lever (▼) : Decreases the volume
- [] icon, **MENU** button : Stops playback

Playing Back Movies

You can play back the movies you have taken in Movie (📽) mode. Sound is played back at the same time.

1 In Playback mode, touch the arrow icons (◀ ▶) to choose the movie to play back.

2 Touch the ▶ icon.

Playback of the movie starts.

The following operations can be performed during playback.

- ⏸ : Pauses playback
- ⏹, MENU button : Stops playback
- ⏮ : Reverse playback
- ⏪ : Returns to normal playback from reverse playback
- 🔊 (Q) : Increases the volume
- 🔇 (🔊) : Decreases the volume

The following operations can be performed while playback is paused.

- ▶ : Resumes playback
- ⏹ : Stops playback
- ⏮ : Frame reverse
- ⏭ : Frame forward

3 Touch the ⏹ icon.

Playback stops.



Playing Back Sound

You can play back the sound files you recorded in Voice Recording (🎤) mode.

- 1 In Playback mode, touch the arrow icons (⏮️ ⏭️) to choose the sound file to play back.**

Length of recording

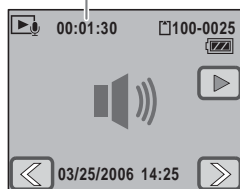

- 2 Touch the ▶️ icon.**

Playback of the sound file starts.

The following operations can be performed during playback.

- ⏸️ : Pauses playback
- ⏹️, **MENU** button : Stops playback
- 🔊 (Q) : Increases the volume
- 🔇 (⊞) : Decreases the volume

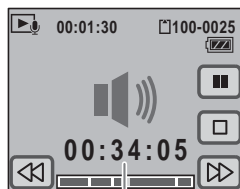

Playback time

If there are no recorded indexes:

- ⏮️ : Fast rewind
- ⏭️ : Fast forward

If there are recorded indexes:

- ⏮️ : Plays back starting from the previous index
- ⏭️ : Plays back starting from the next index

The following operations can be performed while playback is paused.

- ▶️ : Resumes playback
- ⏹️ : Stops playback
- ⏪️ : Rewinds approx. 5 seconds
- ⏩️ : Advances approx. 5 seconds



Memo

- If a sound file contains recorded indexes, the file is rapidly rewound or fast forwarded to the index.
- Press and hold the ⏮️ or ⏭️ icon for more than five seconds to rapidly rewind or fast forward in approximately 20 second intervals.
- You can also touch any point along the bar at the bottom of the screen to specify where you want the sound to rapidly rewind or fast forward to.

Slideshow

You can play back recorded images and movies one after another.

1 In Playback mode, touch the arrow icons (◀ ▶) to choose an image from which to start the slideshow.

2 Touch the LCD monitor.

The [Playback Toolbar] appears.

3 Touch the  icon.

The [Playback Palette] appears.

4 Double-touch the  icon.

- The Slideshow screen appears.
- To bring up the guide display, single-touch the icon.

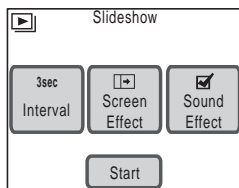

5 Touch [Start].

The slideshow starts.

Touching the LCD monitor during the slideshow pauses the slideshow. Touch [Start] again to resume playback.

6 Press the shutter release button,  button, or MENU button, or turn the zoom lever.

The slideshow stops.



Memo

- The slideshow continues until it is stopped.
- Movies or images with voice memos will be played through to the end before the next file is played back, regardless of the [Interval] setting.
- Sound files made in Voice Recording (🎤) mode are not played back in the slideshow.



Setting the Interval

Touch [Interval] on the Slideshow screen to set the playback interval. Select from [3sec], [5sec], [10sec], [20sec], or [30sec] for setting [Interval].

Touch the icon of the desired duration time to save the setting and return to the Slideshow screen.

Setting the Screen Effect

Touch [Screen Effect] on the Slideshow screen to set the transition effect between images. Select from the following effects.

	Wipe	The next image slides over the previous one from left to right.
	Fade	The current image gradually fades out and the next image fades in.
	Shrink	The image shrinks to a single point and then changes to the next image.
Off	Off	No effect

Touch the icon of the desired effect to save the setting and return to the Slideshow screen.

Setting the Sound Effect

Touch [Sound Effect] on the Slideshow screen to set the sound effect between images.

Except when the [Screen Effect] is set to Off, you can choose (On) or (Off) for the sound that is played when one image changes to the next.

Playing Back on a TV

Instead of using the LCD monitor, you can use the provided AV cable to play back images, movies and sounds on AV equipment with a video IN jack, such as a TV or video projector. Make sure that both the AV equipment and the camera are turned off before connecting the cable.

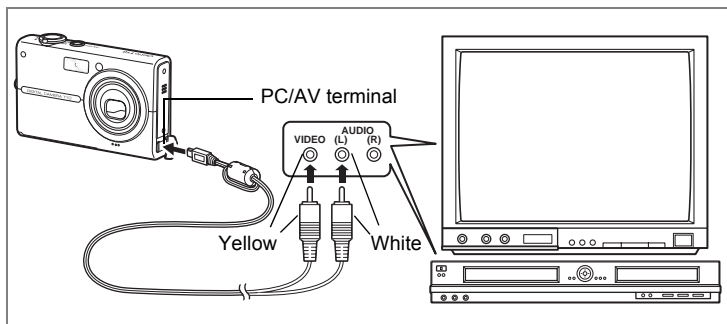

- 1** Connect the AV cable to the PC/AV terminal on the camera.
- 2** Connect the other ends of the AV cable (yellow: video, white: audio) to the AV device's video input terminal and audio input terminal.

When using stereo sound equipment, insert the audio terminal into the L (white) terminal.

When viewing images or movies on AV equipment with multiple video input terminals (such as a TV), refer to the operation manual of the device and select the correct video input terminal to connect the camera to.

- 3** Turn the AV device on.

If multiple AV devices are required for playback, make sure they are all turned on.

- 4** Turn the camera on.

- The camera turns on in Video Out Only mode.
- The camera's LCD monitor turns off while the camera is connected to AV equipment.

5 An operations guide will appear on the TV screen.

- Use the zoom lever, shutter release button,  button, or **MENU** button.

Zoom lever : Selects an icon, switches screens, or performs other operations.

Shutter release button : Sets the setting, switches settings, or performs other operations.

 button : Plays back a movie or sound file.

MENU button : Displays the Video Out Only menu and returns to the previous screen.

- Press the **MENU** button to display the Video Out Only menu.

 : Starts the slideshow.

 : Magnifies the image.

 : Rotates the image.

 : Deletes images and sound files.

 : Selects images and sound files to play back from the list of files.

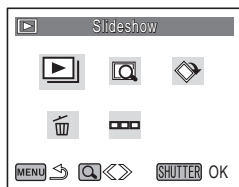

6 Turn off the camera.

7 Disconnect the AV cable from the camera and AV equipment.



Memo

- It is recommended that you use the optional AC adapter kit K-AC7 when connected to AV devices for long periods of time to avoid running down the camera's battery.
- Depending on the country or region, images and sound files may fail to play back if the video output format of the camera does not match the video format in use there. If this happens, change the video output format setting (p.131).
- The camera LCD monitor turns off while the camera is connected to AV equipment.
- The volume cannot be adjusted with the zoom lever while the camera is connected to AV equipment.
- The following operations can be performed when using an optional remote control (p.70).

For Remote control E: Press the shutter release button to play back the next image or movie, and the zoom button to play back the previous image or movie.

For Remote control F: Press the shutter release button to play back the next image or movie.

Deleting Images and Sound Files

Deleting One Image or Sound File

You can delete images and sound files individually.

Caution

- Protected images and sound files cannot be deleted (p.91).
- Images and sound files cannot be deleted when the SD Memory Card's write-protect switch is in the locked position.

1 In Playback mode, touch the arrow icons (◀ ▶) to choose an image or sound file you want to delete.

2 Touch the LCD monitor.

The [Playback Toolbar] appears.

3 Touch the  icon.

The Delete screen appears.

4 Touch [Del. One img/snd].

A confirmation dialog appears.

5 Touch [Delete].

The selected image or sound file is deleted.

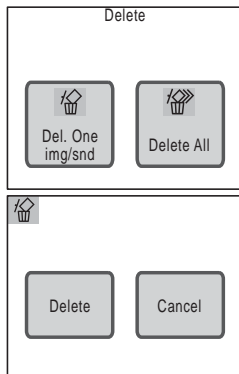

Memo

You can delete the image you have just taken by touching the  icon while the image is displayed.

Deleting a Voice Memo

To delete a voice memo recorded with an image (p.105), touch [Delete Sound] in Step 5. Only the voice memo is deleted. Select [Delete] in Step 5 to delete both the image and sound file.

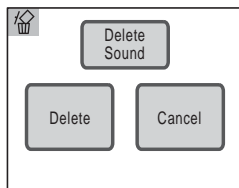

Deleting All Images and Sound Files

You can delete all the images and sound files saved in the camera at once.



Caution

Protected images and sound files cannot be deleted (p.91).

1 In Playback mode, touch the LCD monitor.

The [Playback Toolbar] appears.

2 Touch the icon.

The Delete screen appears.

3 Touch [Delete All].

A confirmation dialog appears.

4 Touch [Delete All].

All the images and sound files are deleted.

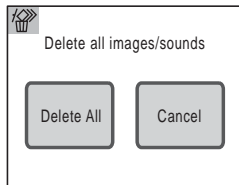

Deleting Selected Images and Sound Files

You can delete several images or sound files selected from the nine-image display at once.

Caution

Protected files cannot be deleted (p.91).

1 In Playback mode, turn the zoom lever toward .

The display switches to nine-image display.





2 Touch the icon.

A (checkbox) appears on the thumbnails.

3 Touch the files that you want to delete.

The on the selected thumbnails turn to .

If you turn the zoom lever toward , you can set the checkbox one by one in single image display mode (The display returns to the nine-image display when you turn the zoom lever toward  or no operations have been performed for more than two seconds.).

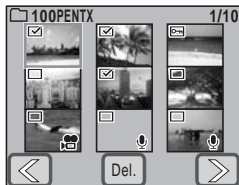

4 Touch [Del.].

A confirmation dialog appears.

5 Touch [Select & Delete].

The selected files are deleted.

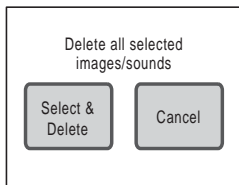

Protecting Images and Sound Files from Deletion

You can protect images and sound files from being accidentally deleted.

1 In Playback mode, touch the LCD monitor.

The [Playback Toolbar] appears.

2 Touch the icon.

The [Playback Palette] appears.

3 Double-touch the icon.

- The Protect screen appears.
- To bring up the guide display, single-touch the icon.

4 Touch [Select Img/Snd].

The screen for choosing an image or sound file to protect appears.

5 Touch the arrow icons () to choose the image or sound file you want to protect.

6 Touch [Protect].

The selected image or sound file is protected.

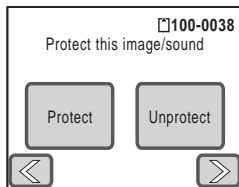
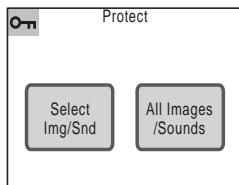

Caution

Protected images and sound files WILL be deleted when the SD Memory Card or built-in memory is formatted.

Memo

- To cancel the Protect setting, touch [Unprotect] in Step 6.
-  appears below the file number on protected images and sound files during playback.

Protecting All Images and Sound Files

1 Touch [All Images/Sounds] on the Protect screen.

A confirmation dialog appears.

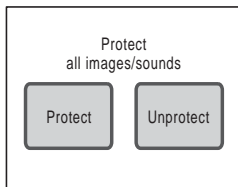

2 Touch [Protect].

All the images and sound files are protected.



Memo

To cancel the Protect setting on all your images and sound files, select [Unprotect] in Step 2.

Editing Images and Movies

Changing the Image Size and Quality (Resize)

By changing the recorded pixels and quality level of an image, you can reduce the file size. You can use this function to continue taking pictures when the SD Memory Card or built-in memory is full, by making the images smaller and overwriting the original images to make more space available in the memory.

1 In Playback mode, touch the arrow icons (◀ ▶) to choose the image you want to resize.

2 Touch the LCD monitor.

The [Playback Toolbar] appears.

3 Touch the  icon.

The [Playback Palette] appears.

4 Double-touch the  icon.

- The Resize screen appears.
- To bring up the guide display, single-touch the icon.
- By default, the same [Recorded Pixels] setting and the [Quality Level] setting at one lower level appear.
To change the settings, touch either [Recorded Pixels] or [Quality Level].

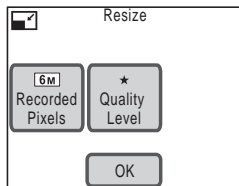

5 Touch [OK].

A save dialog for selecting the save method appears.

6 Touch [Overwrite] or [Save as].

- The resized image is saved.
- Protected images are automatically saved as new files.



Caution

- Movies and sound files cannot be resized.
- You cannot select a larger resolution or higher quality than that of the original image.
- For images with voice memos that are resized and saved as new images, the voice memo is saved together with the new image.

Deleting Unwanted Parts of an Image (Trimming)

You can crop part of an image and save it as a separate image.

1 In Playback mode, touch the arrow icons (◀ ▶) to choose the image you want to trim.

2 Touch the LCD monitor.

The [Playback Toolbar] appears.

3 Touch the  icon.

The [Playback Palette] appears.

4 Double-touch the  icon.

- The Trimming screen appears.
- To bring up the guide display, single-touch the icon.



5 Set the size of the trimming frame and the area to trim.

- By default, the trimming frame is displayed at its maximum size.
- To change the size of the trimming frame, use the zoom lever or touch [ChangeSize].
- You can move the trimming frame by dragging it.

6 Touch [OK].

The trimmed image is saved with a new file name.



Caution

Movies cannot be trimmed.



Memo

- The trimmed image will be saved at the same quality setting as the original image.
- For images with voice memos that are trimmed and saved as new images, the voice memo is saved together with the new image.

6 Use the drawing tools on the right of the screen to make a drawing or add stamps.

Touch the icon of a drawing tool to select each function.

 : Closes the toolbar.

 : Lets you select the color, hardness, and type of line.

 : Lets you choose one of 12 different stamps.

 : Use this to cut out part of the image to create your own stamp.

 : Choose from the stamps you have created (save up to four stamps).

 : Erases a drawing or stamp.



7 Touch [OK].

The screen returns to the Special Effect screen.

8 Touch [Exit].

A save dialog for selecting the save method appears.

9 Touch [Overwrite] or [Save as].

- The edited image is saved.
- Protected images are automatically saved as new images.

Caution

- You cannot make drawings on pictures that are **640** in size or movies.
- Images of size **3M** and larger are resized to **2M** when a drawing is made.

Choosing a Line

Touch the  icon in Step 6 to display the Line Selection screen.

Choose a color (black, red, blue, yellow, white, or pink), hardness, and type of line, and touch [OK].

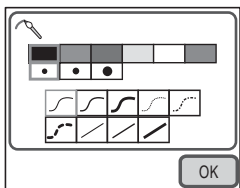

Adding a Stamp

Touch the  icon in Step 6 to display the Stamp Selection screen.

Choose from 12 stamps by touching the stamp you want to use, and touch [OK].

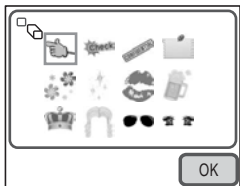

Creating Your Own Stamps (“My Stamp”)

1 Touch the icon.

The Image Cutting screen appears.

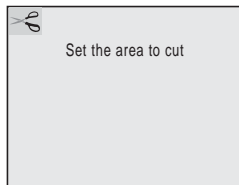

2 Drag your finger or the stylus over the area you want to cut.

- Draw an unbroken line to select the area you want to cut.
- To change the area to be cut, press the **MENU** button and re-select the area to be cut.

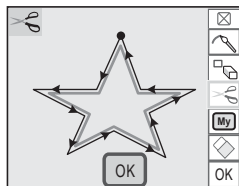

3 Touch [OK].

A confirmation dialog for creating the stamp appears.

4 Touch [Save].

The stamp is created.

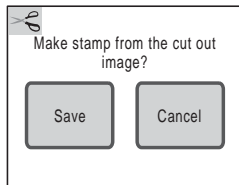

Memo

You can create up to four stamps.

Using My Stamp

1 Touch the icon.

The My Stamp Selection screen appears.

2 Touch the stamp you want to use.

- The stamp is added to the image.
- To delete a stamp, touch [Delete].

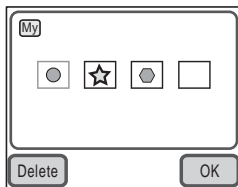

Using the Eraser

Touch the  icon to display the Eraser Selection screen.

Touch the type of eraser you want to use, and touch [OK].

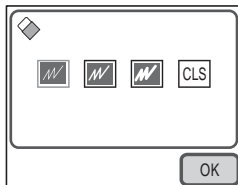

4



Memo

To clear and reset the edits you made in Drawing mode, touch [CLS] on the screen (The stamps you have stored are not cleared).

Adding a Frame to an Image (Frame Composite)

You can add a decorative frame to a picture you have taken. There are seven frames available in the camera.

1 In Playback mode, touch the arrow icons (◀ ▶) to choose the image to decorate.

2 Touch the LCD monitor.

The [Playback Toolbar] appears.

3 Touch the  icon.

The [Playback Palette] appears.

4 Double-touch the  icon.

- The Special Effect screen appears.
- To bring up the guide display, single-touch the icon.

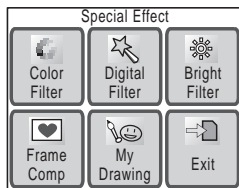

5 Touch [Frame Comp].

The Frame Selection screen appears.

6 Touch the arrow icons (◀ ▶) to choose the frame to add.

7 Touch [OK].

The camera returns to the Special Effect screen.

8 Touch [Exit].

A save dialog for selecting the save method appears.

9 Touch [Overwrite] or [Save as].

- The image with the added frame is saved.
- Protected images are automatically saved as new files.

 **Caution**

- Frames cannot be added to pictures that are **2M** or smaller in size or movies.
- Images of size **4M** and larger are resized to **3M** when a frame is added.

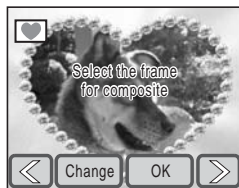

Adding New Decorative Frames

Touch [Change] in Step 6 to switch to the screen for adding a new frame. You can add frames you have downloaded from the Internet and other sources. Before adding a downloaded frame, copy it first to the SD Memory Card.



Caution

When a new frame on the SD Memory Card is added to the built-in memory, it replaces one of the existing frames in the built-in memory. The replaced frame is deleted from the built-in memory.

1 In the Frame Selection screen, choose the frame you want to replace and touch [Change].

A message appears and the frames on the SD Memory Card appear.

2 Touch the arrow icons (◀ ▶) to choose the frame to register.



3 Touch [OK].

The frame is added to the built-in memory in place of the frame selected in Step 1.

Visit the PENTAX website at the address below to download new frames.
http://www.pentax.co.jp/english/support/digital/optio_frame.html





Changing the Image Color Tone (Color Filter)

You can use the Color Filter function to change the color tone of images. You can choose from 13 color filters: B&W, sepia, color (8 variations), B&W+Red, B&W+Green, and B&W+Blue.

- 1 In Playback mode, touch the arrow icons (◀ ▶) to choose the image for which you want to change the color tone.**
- 2 Touch the LCD monitor.**
The [Playback Toolbar] appears.
- 3 Touch the  icon.**
The [Playback Palette] appears.
- 4 Double-touch the  icon.**
 - The Special Effect screen appears.
 - To bring up the guide display, single-touch the icon.
- 5 Touch [Color Filter].**
The screen for changing the color tone appears.
- 6 Touch the color filter you want to use.**
You can preview the results of the selected color filter.
- 7 Touch [OK].**
The screen returns to the Special Effect screen.
- 8 Touch [Exit].**
A save dialog for selecting the save method appears.
- 9 Touch [Overwrite] or [Save as].**
 - The image with the added effect is saved.
 - Protected images are automatically saved as new files.



Changing the Image Brightness (Bright Filter)

- 1 In Playback mode, touch the arrow icons (⏪ ⏩) to choose the image for which you want to change the brightness.
- 2 Touch the LCD monitor.
The [Playback Toolbar] appears.
- 3 Touch the  icon.
The [Playback Palette] appears.
- 4 Double-touch the  icon.
 - The Special Effect screen appears.
 - To bring up the guide display, single-touch the icon.
- 5 Touch the [Bright Filter] icon.
The Brightness Adjustment screen appears.
- 6 Touch the  or  icon to adjust the brightness.
 - You can preview the results of the brightness adjustment.
 - You can also drag the cursor along the brightness bar to the desired setting.
- 7 Touch [OK].
The screen returns to the Special Effect screen.
- 8 Touch [Exit].
A save dialog for selecting the save method appears.
- 9 Touch [Overwrite] or [Save as].
 - The image with the added effect is saved.
 - Protected images are automatically saved as new files.



Brightness bar

Digital Filter Effects

You can use digital filters to give an image softness, make it look like an illustration, or make the subjects look broader or more slender.

1 In Playback mode, touch the arrow icons (◀ ▶) to choose the image you want to edit.

2 Touch the LCD monitor.

The [Playback Toolbar] appears.

3 Touch the  icon.

The [Playback Palette] appears.

4 Double-touch the  icon.

- The Special Effect screen appears.
- To bring up the guide display, single-touch the icon.

5 Touch the  icon.

The Digital Filter Selection screen appears.

6 Touch the digital filter you want to use.

You can preview the results of the selected digital filter.



 : Softens the image.

 : Makes the image look like an illustration.

 : Gives the image artistic texture which looks like sprinkling star dust.

 : Makes the subject appear broader or more slender.

7 Touch [OK].

The screen returns to the Special Effect screen.

8 Touch [Exit].

A save dialog for selecting the save method appears.

9 Touch [Overwrite] or [Save as].

- The image with the added effect is saved.
- Protected images are automatically saved as new files.

Removing Red-eye

You can correct images where the flash has caused the subject to appear with red eyes.

1 In Playback mode, touch the arrow icons (◀ ▶) to choose the image for which you want to use the red-eye compensation function.

2 Touch the LCD monitor.

The [Playback Toolbar] appears.

3 Touch the  icon.

The [Playback Palette] appears.

4 Double-touch the  icon.

- The red-eye compensation function tries to correct the image. If it is able to correct the image, the screen in Step 7 appears, and you can save the image.

If it is not able to correct the image, the Red-eye Compensation screen appears after touching [OK] on the error screen. In this case, follow the steps below and select the area for red-eye compensation manually.

- To bring up the guide display, single-touch the icon.



5 Touch the area you want to correct.

You can select multiple areas for red-eye compensation before touching [OK].

6 Touch [OK].

A save dialog for selecting the save method appears.

7 Touch [Overwrite] or [Save as].

- The corrected image is saved.
- Protected images are automatically saved as new files.



Caution

- The red-eye compensation function cannot be used on movies or for pictures where red eyes are smaller than a certain size.
- At least one example of red-eye must be detected in the picture for red-eye compensation to work and the image to be subsequently saved.
- The red-eye compensation function can only be used on pictures taken with this camera.

Adding Sound to an Image (Voice Memo)

You can add sound (voice memo) to pictures you have taken.

1 In Playback mode, touch the arrow icons (◀ ▶) to choose the image to which you want to add a voice memo.

2 Touch the LCD monitor.

The [Playback Toolbar] appears.

3 Touch the  icon.

The [Playback Palette] appears.

4 Double-touch the  icon.

- The camera starts recording. You can record up to 60 seconds.
- To bring up the guide display, single-touch the icon.

5 Touch the  icon.

Recording stops.



Recording time

Caution

- A voice memo cannot be added to an image that already has a voice memo. Delete the old voice memo before recording a new one (p.89).
- A voice memo cannot be added to a protected image.

Memo

Refer to “Deleting a Voice Memo” (p.89) for information about how to delete a voice memo.

Setting an Image for the Start-up Screen

You can choose an image saved on the SD Memory Card to be displayed as the start-up screen when the camera is turned on.

1 In Playback mode, touch the arrow icons (◀ ▶) to choose the image you want to use as the start-up screen.

2 Touch the LCD monitor.

The [Playback Toolbar] appears.

3 Touch the  icon.

The [Playback Palette] appears.

4 Double-touch the  icon.

- The setting screen appears.
- To bring up the guide display, single-touch the icon.

5 Touch the arrow icons (◀ ▶) to select a new start-up screen.

- You can choose from the image displayed on the LCD monitor, the current start-up screen, any of the three built-in start-up screens, or a screen which is "off".
- Select the "off" screen to not display a start-up screen.



6 Touch [OK].



The start-up screen setting is saved.



Caution

Once an image has been selected as the start-up screen, it will not be deleted even if the original image is deleted or the SD Memory Card or built-in memory is formatted. However, if the camera is returned to its default settings, the image will be deleted (p.136).

Saving a Frame from a Movie as a Still Image

- 1 In Playback mode, touch the arrow icons (◀ ▶) to choose the movie you want to use to capture a still image.
- 2 Touch the LCD monitor.
The [Playback Toolbar] appears.
- 3 Touch the  icon.
The [Playback Palette] appears.
- 4 Double-touch the  icon.
 - The Movie Edit screen appears.
 - To bring up the guide display, single-touch the icon.
- 5 Touch the ◀ ▶ icons to choose the frame you want to save as a still image.
 - Touch the ▶ icon to play back the movie, and touch the ◻ icon to stop playback.
 - Touching the ◻ icon during playback pauses the movie.
- 6 Touch [OK].
The selected frame is saved as a still image.



Copying Images and Sound Files

For copying images and sound files from the built-in memory to the SD Memory Card and vice versa.

Caution

- You cannot use this function if no SD Memory Card is inserted in the camera.
- Make sure that the camera is turned off before inserting or removing the SD Memory Card.
- Images and sound files cannot be copied from the built-in memory to the SD Memory Card unless the SD Memory Card has sufficient space. Before copying the data, make sure that there is enough space on the SD Memory Card.

1 In Playback mode, touch the LCD monitor.

The [Playback Toolbar] appears.

2 Touch the icon.

The [Playback Palette] appears.

3 Double-touch the icon.

- The Image/Sound Copy screen appears.
- To bring up the guide display, single-touch the icon.

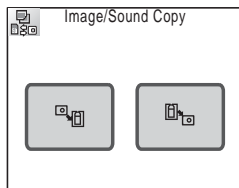

To Copy Files from the Built-in Memory to the SD Memory Card

All the images and sound files in the built-in memory can be copied to the SD Memory Card at once.

4 Touch the icon.

All the images and sound files are copied.

To Copy Files from the SD Memory Card to the Built-in Memory

Selected images and sound files can be copied from the SD Memory Card to the built-in memory one at a time.

4 Touch the  icon.

5 Touch the arrow icons ( ) to choose the file to copy.

6 Touch [OK].

The selected image or sound file is copied.



Memo

- If sound has been recorded with the image, the sound file is copied with the image.
- Protected images, movies, and sound files are still protected after they have been copied.



5 Printing Images

Printing with DPOF

The Digital Print Order Format (DPOF) stores printing information for pictures so they can automatically be printed on a DPOF-compatible printer or at DPOF-enabled photo processing labs.

Applying the DPOF Settings to Each Image

Specify the number of copies for each image and if you want the date to appear on the print.

1 In Playback mode, touch the arrow icons ( ) to choose the first image you want to print.

2 Touch the LCD monitor.

The [Playback Toolbar] appears.

3 Touch the  icon.

The [Playback Palette] appears.

4 Double-touch the  icon.

- The DPOF screen appears.
- To bring up the guide display, single-touch the icon.

5 Touch [Print One].

The DPOF Setting screen appears.

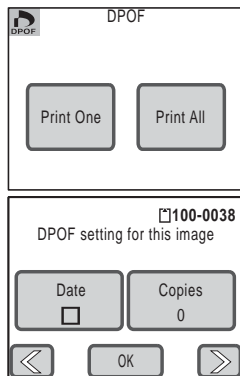

6 Touch [Date].

The setting changes to (On) or (Off).

: The date will be imprinted.

: The date will not be imprinted.

7 Touch [Copies].

The Copies screen appears.

8 Touch the arrow icons (⏮ ⏭) to specify the number of copies.

You can print up to 99 copies.

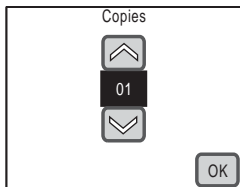
**9 Touch [OK].**

The DPOF Setting screen in Step 5 appears.

10 Touch the arrow icons (⏮ ⏭) to choose the next image, and then repeat Steps 6 to 9.**11 Touch [OK].**

The DPOF settings are saved.

 Caution

Depending on the printer or printing equipment at the photo processing lab., the date may not be imprinted on the pictures even if you set the DPOF settings.

 Memo

- You can set the number up to 99 copies.
- To cancel DPOF settings, set the number of copies to "00" in Step 8.

Applying the DPOF Settings to All Images

The same number of copies and the same date setting are applied to all the images stored in the camera.

1 In Playback mode, touch the LCD monitor.

The [Playback Toolbar] appears.

2 Touch the icon.

The [Playback Palette] appears.

3 Double-touch the icon.

- The DPOF Setting screen appears.
- To bring up the guide display, single-touch the icon.

4 Touch [Print All].

The DPOF screen appears.

5 Specify the number of copies and if you want the date to appear on the print.

Refer to Steps 6 to 9 in “Applying the DPOF Settings to Each Image” (p.111) for details of how to make the settings.

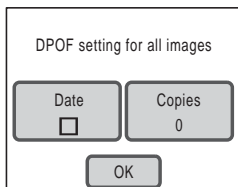

6 Touch [OK].

The DPOF settings are saved.

Caution

When settings are made for all images, the number of copies applies to all the images. Before printing, check that the number is correct.

Memo

When settings are made for all images, the settings for individual images are cancelled.

Direct Printing with PictBridge

By connecting the camera to a PictBridge-compatible printer with the provided USB cable, you can print images directly from the camera without using a PC. Connect the camera to the printer and use the camera to choose the images you want to print, the number of copies, and whether you want the date to appear on the print.

Caution

- It is recommended that you use the optional AC adapter kit when printing images directly from the camera. The printer may not work properly or image data may be lost if the camera battery runs out of power while the camera is connected to the printer.
- Do not disconnect the USB cable during data transfer.
- Depending on the printer model, not all the settings made on the camera (such as date and DPOF settings) may be executed.
- Printing an index of images, where multiple images appear on a single sheet, may not be possible unless the printer supports index printing. For index prints, you may need to use a PC.

Connecting the Camera to the Printer

1 Select [PictBridge] for the [USB Connection] mode.

Refer to “Changing the USB Connection Mode” (p.130) for details of how to set the [USB Connection] mode.

2 Turn off the camera.

3 Connect the camera to the printer using the USB cable provided.

4 Turn the printer on.

5 When the printer is ready to print, turn the camera on.

The Printing Mode Selection screen appears.

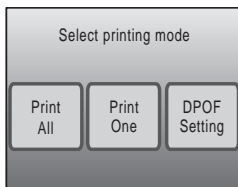

Printing Single Image

1 In the Printing Mode Selection screen, touch [Print One].

The setting screen appears.

2 Touch [Date].

The setting changes to (On) or (Off).

: The date will be imprinted.

: The date will not be imprinted.

3 Touch [Copies].

The Copies screen appears.

4 Touch the arrow icons (▲▼) to specify the number of copies.

- You can print up to 99 copies.
- Touch [OK]. The screen in Step 1 appears.

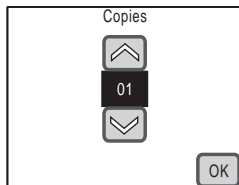
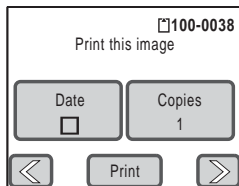

5 Touch [Print].

- A confirmation dialog appears.
- To change the print settings, refer to "Changing the Print Settings" (p.115).

6 Touch [Print].

- Printing starts.
- Touch [Printing Cancel] during printing to cancel printing.

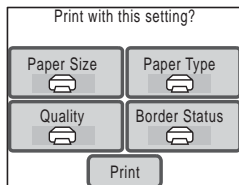

Changing the Print Settings

5 Touch [Print].

A confirmation dialog appears.

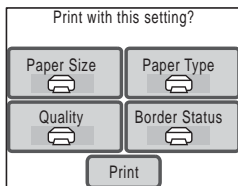

6 Touch [Paper Size].

The Paper Size screen appears.

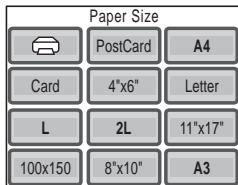

7 Touch a desired paper size from the selections.

You can only choose a size that is supported by your printer.

8 Repeat Steps 6 to 7 for [Paper Type], [Quality] and [Border Status].

- If you select , images are printed according to the settings on the printer.
- When you touch [Paper Type], the more ★ the higher the quality of paper you can use.
- When you touch [Quality], the more ★ the higher the print quality will be.

9 Touch [Print].

- The image is printed according to the settings.
- Touch [Printing Cancel] during printing to cancel printing.



Memo

- The power indicator lights while the camera is communicating with the printer, and blinks while the card is being accessed and during printing. Do not disconnect the USB cable while the power indicator is blinking.
- The [Paper Size], [Paper Type], [Quality] and [Border Status] settings are reset to their defaults when the camera is turned off.

Printing All Images

1 In the Printing Mode Selection screen (Step 5 on p.113), touch [Print All].

The setting screen appears.

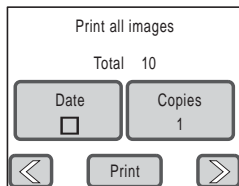

2 Specify the number of copies and if you want the date to appear on the print.

Refer to Steps 2 to 4 in “Printing Single Image” (p.114) for how to make the settings.

3 Touch [Print].

- A confirmation dialog appears.
- Refer to “Changing the Print Settings” (p.115) for how to change the print settings.

5 4 Touch [Print].

- Printing starts.
- Touch [Printing Cancel] during printing to cancel printing.

Printing Using the DPOF Settings

1 In the Printing Mode Selection screen (Step 5 on p.113), touch [DPOF Setting].

- The settings you have made appear.
- Touch to check the settings for each image.

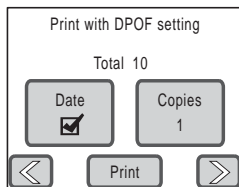

2 Touch [Print].

- A confirmation dialog appears.
- Refer to “Changing the Print Settings” for how to change the print settings (p.115).

3 Touch [Print].

- Printing starts.
- Touch [Printing Cancel] during printing to cancel printing.

Disconnecting the USB Cable

Disconnect the USB cable from the camera and printer when you have finished printing.

- 1 Turn off the camera.**
- 2 Disconnect the USB cable from the camera and printer.**

Using the Setting Menu

In Capture or Playback mode, press the **MENU** button to display the menu for setting the various camera functions. This section explains how to set the [Sound] and [Setting] menu items (For [Rec. Mode 1], [Rec. Mode 2], [Movie], and [Common], refer to p.34.)

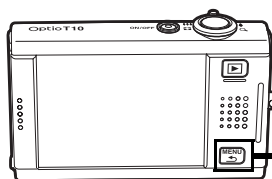

Press the **MENU** button.

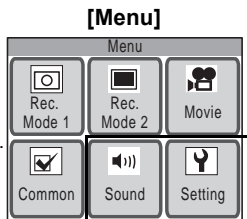

Touch the desired icon.

- Press the shutter release button to return to Capture mode.
- Press the button to return to Playback mode.
- Press the **MENU** button to return to the previous screen.
- If no operation is performed for a certain period of time, the camera returns to Capture mode or Playback mode.

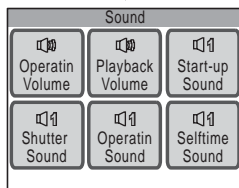

Touch the desired icon.

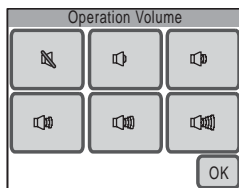

Touch the desired icon.

Continue with operations while following the on-screen guidance.

Available Settings with [Sound] icon

Item	Description	Default Setting	Page
Operation Volume	Sets the volume of the operation sounds.	3	p.123
Playback Volume	Sets the volume of movies and sound files.	3	p.123
Start-up Sound	Sets the start-up sound.	1	p.124
Shutter Sound	Sets the shutter sound.	1	p.124
Operation Sound	Sets the operation sound.	1	p.124
Self-timer Sound	Sets the countdown sound of the self-timer.	1	p.124

Available Settings with [Setting] icon

Item	Description	Default Setting	Page
Format	Formats the SD Memory Card or built-in memory.	—	p.120
Date Adjust	Adjusts the date, time, and their display styles.	Depends on the Initial Setting	p.121
World Time	Sets the world time.	Off	p.125
Language/言語	Sets the display language in which menus and messages appear.	Depends on the Initial Setting	p.128
Folder Name	Images and sound files can be saved to a separate folder by date.	Standard	p.129
USB Connection	Sets the USB cable connection.	PC	p.130
Video Out	For setting the video output format to match AV equipment.	Depends on the Initial Setting	p.131
Brightness Level	Adjusts the brightness of the LCD monitor.	4 (Normal)	p.132
Power Saving	Sets the amount of time the LCD monitor will stay on before it turns off automatically.	5 sec.	p.133
Auto Power Off	Sets the amount of time the camera will stay on before it turns off automatically.	3 min.	p.134
Guide Display	Sets the guide display to On or Off.	On	p.135
Reset	Returns all camera settings to their default values except for date and time, language, world time, and video output format.	—	p.136

Formatting an SD Memory Card and the Built-in Memory

Formatting will delete all the data in the built-in memory or on the SD Memory Card.

If an SD Memory Card is in the camera, all its data will be deleted. If no SD Memory Card has been inserted in the camera, all the data in the built-in memory will be deleted.

Caution

- Do not remove the SD Memory Card during formatting as this may damage the card and render it unusable.
- A write-protected SD Memory Card cannot be formatted (p.19).
- Formatting will delete ALL data including protected images, sound files, and any other data recorded on the card.
- SD Memory Cards formatted on a PC or device other than this camera cannot be used. Be sure to format the card with this camera.
- If you are going to discard, give away or sell your SD memory card you should ensure that the data on the card is completely deleted or the card itself is destroyed if it contains any personal or sensitive information. Please note that formatting the SD card will not necessarily delete the data so that it cannot be recovered using off the shelf data recovery software. There are off the shelf secure data deletion software programs available that will completely delete the data. In any case the data on your SD memory card should be managed at your own risk.

1 Press the MENU button.

The [Menu] appears.

2 Touch [Setting].

The Setting screen appears.

3 Touch [Format].

The Format screen appears.

4 Touch [Format].

Formatting starts. When formatting is completed, the camera is ready to take pictures.

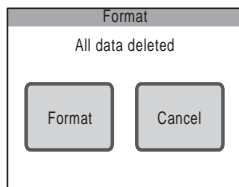

Changing the Date and Time

You can change the date and time settings. You can also set the style in which the date and time appear.

Setting the Date Style

1 Press the **MENU** button.

The [Menu] appears.

2 Touch [Setting].

The Setting screen appears.

3 Touch [Date Adjust].

The Date Adjust screen appears.

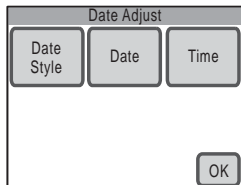

4 Touch [Date Style].

The Date Style screen appears.

5 Touch the arrow icons (◀ ▶) to choose the display style of the year, month, and day.

Select [mm/dd/yy], [dd/mm/yy] or [yy/mm/dd].

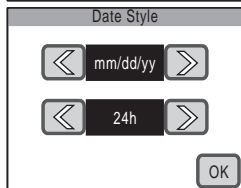

6 Touch the arrow icons (◀ ▶) to choose the time display style.

Select [24h] (24-hour display) or [12h] (12-hour display).

7 Touch [OK].

The setting is saved and the screen returns to the Date Adjust screen with the selected date style.

Setting the Date

- 1 Touch [Date] on the Date Adjust screen.

The Date screen appears.

- 2 Touch the arrow icons (⬆️⬇️) to set the date.

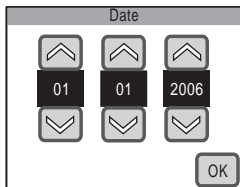

- 3 Touch [OK].

The setting is saved and the screen returns to the Date Adjust screen.

Setting the Time

- 1 Touch [Time] on the Date Adjust screen.

The Time screen appears.

- 2 Touch the arrow icons (⬆️⬇️) to set the time.

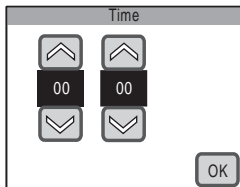

- 3 Touch [OK].

The setting is saved and the screen returns to the Date Adjust screen.

Memo

When you finish the settings and touch [OK], the camera clock is reset to 00 seconds. To set the exact time, touch [OK] when the time signal (on the TV, radio, etc.) reaches 00 seconds.

Changing the Sound Settings

You can adjust the volume of operation and playback sounds and change the type of start-up sound, shutter sound, operation sound, and self-timer sound. You can also turn off the sounds.

1 Press the **MENU** button.

The [Menu] appears.

2 Touch **[Sound]**.

The Sound screen appears.

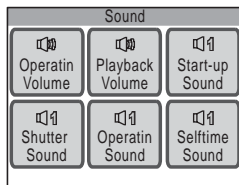

Changing the Volume

1 Touch **[Operation Volume]** on the **Sound** screen.

The Operation Volume screen appears.

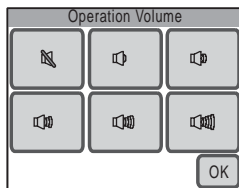

2 Touch the icon of the operation volume you want to set.

Choose from six volume levels (0) to (5). Set the volume to (0) to mute the sound.

3 Touch **[OK]**.

The setting is saved and the screen returns to the Sound screen.

Changing the Start-up Sound, Shutter Sound, Operation Sound, Self-timer Sound Type

1 Touch the desired sound setting icon on the Sound screen.

The setting screen appears.

2 Touch the icon of the sound type you want to set.

- Select [1], [2], [3], [USER], or [Off]. When an icon is touched, the selected sound is played back. Select [Off] to turn off the sound.
- By selecting [USER], you can assign the first two seconds of a recorded sound file as the sound type.

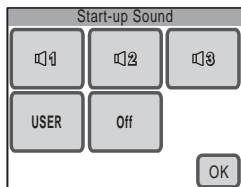

3 Touch [OK].

The setting is saved and the screen returns to the Sound screen.

Setting the User Sound

1 In Step 2 above, touch [USER], and then touch [OK].

The Playback screen appears if there is a sound that can be used as the user sound in the camera.

2 Touch the arrow icons (◀ ▶) to choose the sound.

- ▶ : Plays back the first two seconds of the sound file.
- ◻ : Stops playback.

3 Touch [OK].

- The setting is saved and the screen returns to the Sound screen.
- The first two seconds of the selected sound is set as the user sound.



Setting the World Time

The date and time selected with the procedure in “Setting the Language and the Date and Time” (p.21) and “Changing the Date and Time” (p.121) serve as the Hometown date and time. By using the world time function, you can display the time in a city other than the Hometown (Destination). This is useful when taking pictures in a different time zone.

Setting the Destination

1 Press the MENU button.

The [Menu] appears.

2 Touch [Setting].

The Setting screen appears.

3 Touch [World Time].

The World Time screen appears.



4 Touch [Destination].

The Destination screen appears. The city that is currently selected turns green on the map.

5 Touch the arrow icons (◀ ▶) to select the destination city on the map.

You can also pan the map by dragging it.



6 Touch the arrow icons (◀ ▶) to choose the destination city.

The current time of the selected city appears.

7 Touch the DST icon.

The DST screen appears.

8 Touch [On] or [Off].

[On] : Turns on the daylight saving time setting.

[Off] : Turns off the daylight saving time setting.

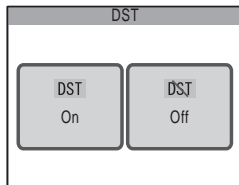

The setting is saved and the screen returns to the Destination screen.

9 Press the MENU button.

The World Time screen appears.

Displaying the Destination Time

1 Touch [Select Time] on the World Time screen.

The Select Time screen appears.

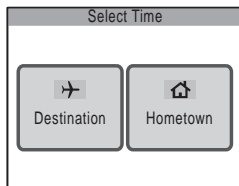

2 Touch [Destination].

The time setting for the destination city is saved and the screen returns to the World Time screen.

3 Press the MENU button three times.

- The camera returns to Capture mode. When [World Time] is set, ✈ appears on the LCD monitor.
- Press the ▶ button to return to Playback mode.



Memo

Touch [Hometown] in Step 4 on p.125 to select the Hometown city and DST option.

Refer to the following list of cities when setting the World Time.

Region	City	Region	City
North America	Honolulu	Africa/ West Asia	Jerusalem
	Anchorage		Nairobi
	Vancouver		Jeddah
	San Francisco		Tehran
	Los Angeles		Dubai
	Calgary		Karachi
	Denver		Kabul
	Chicago		Male
	Miami		Delhi
	Toronto		Colombo
	New York	Kathmandu	
	Halifax	Dacca	
Central and South America	Mexico City	East Asia	Yangon
	Lima		Bangkok
	Santiago		Kuala Lumpur
	Caracas		Vientiane
	Buenos Aires		Singapore
	Sao Paulo		Phnom Penh
	Rio de Janeiro		Ho Chi Minh
Europe	Lisbon		Jakarta
	Madrid		Hong Kong
	London		Beijing
	Paris		Shanghai
	Amsterdam		Manila
	Milan		Taipei
	Rome	Seoul	
	Berlin	Tokyo	
	Stockholm	Guam	
	Athens	Oceania	Perth
	Helsinki		Adelaide
	Moscow		Sydney
Dakar	Noumea		
Algiers	Wellington		
Johannesburg	Auckland		
Istanbul	Pago Pago		
Cairo			

Changing the Display Language

You can change the language in which information appears on the LCD monitor of the camera.

You can choose from Japanese, English, French, German, Spanish, Portuguese, Italian, Swedish, Dutch, Russian, Thai, Korean, and Chinese (traditional and simplified).

1 Press the MENU button.

The [Menu] appears.

2 Touch [Setting].

The Setting screen appears.

3 Touch [Language/言語].

The Language/言語 screen appears.

4 Touch the desired language.

- The setting is saved and the screen returns to the previous screen.
- If the desired language does not appear, touch the arrow icons (◀▶) to advance the screen and select the language.





5 Press the MENU button twice.

- The camera returns to Capture mode.
- Press the ▶ button to return to Playback mode.

Changing a Folder Name

You can choose how names are assigned to folders for storing images and sound files. When [Date] is selected, images and sound files are saved in separate folders by the date they were taken or recorded.

Folder Naming Method

	Standard	XXXPENTX (where XXX is the 3-digit folder number) Stores up to 500 files in the same folder. However, the maximum file number is 9999.
	Date	XXX_mmdd (3-digit folder number_month and day) Stores files in folders organized by date.

Picture taken with Standard folder naming method

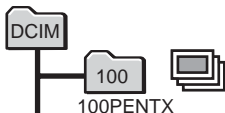

Folder name changed to [Date] setting

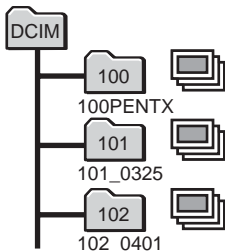

1 Press the MENU button.

The [Menu] appears.

2 Touch [Setting].

The Setting screen appears.

3 Touch [Folder Name].

The Folder Name screen appears.

4 Touch the (Standard) or (Date) icon.

The setting is saved and the screen returns to the previous screen.

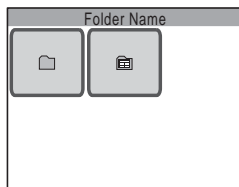

5 Press the MENU button twice.

- The camera returns to Capture mode.
- Press the  button to return to Playback mode.

Changing the USB Connection Mode

Choose the appropriate USB connection mode depending on whether you are going to connect the USB cable to a PC or a PictBridge-compatible printer.

1 Press the **MENU** button.

The [Menu] appears.

2 Touch [Setting].

The Setting screen appears.

3 Touch [USB Connection].

The USB Connection screen appears.

4 Touch the (PC) or (PictBridge) icon.

 : Uses to transfer image and sound data to a PC.

 : Uses to connect the camera to a PictBridge-compatible printer.

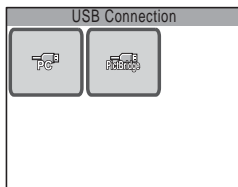



The setting is saved and the screen returns to the previous screen.

5 Press the **MENU** button twice.

- The camera returns to Capture mode.
- Press the  button to return to Playback mode.

Caution

Do not connect the camera to your printer while  (PC) is selected for the USB Connection mode, and do not connect the camera to your computer while  (PictBridge) is selected.

Memo

Refer to the supplied "PC Connection Manual" for instructions on how to connect the camera to a computer.

Changing the Video Output Format

When you connect the camera to AV equipment, choose the appropriate video output format (NTSC or PAL) to play back images.

Depending on the country or region, images, sound files, and movies may not play back if the video output format of the camera does not match the video format used there. If this happens, change the video output format setting.

1 Press the MENU button.

The [Menu] appears.

2 Touch [Setting].

The Setting screen appears.

3 Touch [←].

The next page of the Setting screen appears.

4 Touch [Video Out].

The Video Out screen appears.

5 Touch [NTSC] or [PAL].

- Choose the video output format to match the output format of the AV equipment.
- The setting is saved and the screen returns to the previous screen.

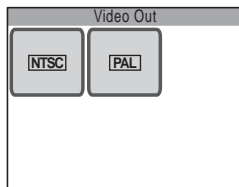

6 Press the MENU button twice.

- The camera returns to Capture mode.
- Press the [▶] button to return to Playback mode.

Adjusting the Brightness of the LCD Monitor

1 Press the MENU button.

The [Menu] appears.

2 Touch [Setting].

The Setting screen appears.

3 Touch [◀].

The next page of the Setting screen appears.

4 Touch [Brightness Level].

The Brightness Level screen appears.

5 Touch the [−] or [+] icon to adjust the brightness.

- Touch the [−] icon to make the monitor darker and the [+] icon to make the monitor brighter.
- You can also drag the cursor along the bar to the desired setting.



6 Touch [OK].

The setting is saved and the screen returns to the previous screen.

7 Press the MENU button twice.

- The camera returns to Capture mode.
- Press the [▶] button to return to Playback mode.

Using the Power Saving Function

You can save battery power by setting the LCD monitor to turn off automatically when no operations have been performed for a predetermined time period. After the power saving function is activated, you can turn the LCD monitor on again by pressing any button on the camera.

1 Press the MENU button.

The [Menu] appears.

2 Touch [Setting].

The Setting screen appears.

3 Touch [⏪].

The next page of the Setting screen appears.

4 Touch [Power Saving].

The Power Saving screen appears.

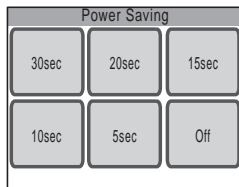

5 Choose the duration time until the LCD monitor turns off.

- Select [30sec], [20sec], [15sec], [10sec], [5sec], or [Off].
- The setting is saved and the screen returns to the previous screen.

6 Press the MENU button twice.

- The camera returns to Capture mode.
- Press the [▶] button to return to Playback mode.



Memo

Power Saving does not function in the following situations:

- when using the AC adapter
- while recording a movie
- when recording a voice memo
- when using the self-timer
- when playing back a sound file or movie
- during a slideshow
- during video output

Setting Auto Power Off

You can set the camera to turn off automatically when no operations have been performed for a predetermined time period.

1 Press the **MENU** button.

The [Menu] appears.

2 Touch [**Setting**].

The Setting screen appears.

3 Touch [**↵**].

The next page of the Setting screen appears.

4 Touch [**Auto Power Off**].

The Auto Power Off screen appears.

5 Choose the duration time until the power turns off.

- Select [5min], [3min], or [Off] (do not turn off).
- The setting is saved and the screen returns to the previous screen.

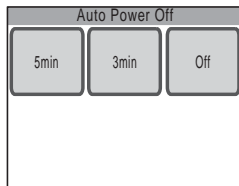

6 Press the **MENU** button twice.

- The camera returns to Capture mode.
- Press the **▶** button to return to Playback mode.



Memo

Even when set to [5min] or [3min], Auto Power Off will not function when the camera is connected to a PC or printer.

Setting the Guide Display

You can choose whether or not the guide display will appear when an icon is touched on the [Capture Palette] or [Playback Palette]. The guide display provides a description of each icon's function.

1 Press the MENU button.

The [Menu] appears.

2 Touch [Setting].

The Setting screen appears.

3 Touch [▽].

The next page of the Setting screen appears.

4 Touch [Guide Display].

The setting changes to (On) or (Off).

- : Turns on the guide display.
- : Turns off the guide display.

5 Press the MENU button twice.

- The camera returns to Capture mode.
- Press the  button to return to Playback mode.

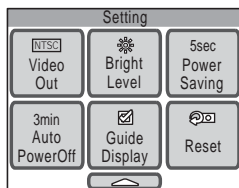

Memo

Even when [Guide Display] is set to On, you can bypass it by double-touching the icon.

Returning Changed Settings to Their Defaults (Reset)

You can reset the camera settings to their defaults.

The language, date and time, world time, and video output format are not affected.

1 Press the MENU button.

The [Menu] appears.

2 Touch [Setting].

The Setting screen appears.

3 Touch [↩].

The next page of the Setting screen appears.

4 Touch [Reset].

The Reset screen appears.

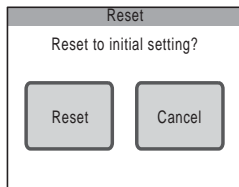

5 Touch [Reset].

The settings are reset and the camera returns to Capture mode.

Charging the Battery Abroad

The battery charger supplied with the camera is designed to switch automatically to the voltage (100 - 240V) and frequency (50Hz, 60Hz) of the electricity supply in the country or region where used.

However, electrical socket shapes differ from country to country. Before traveling abroad, you are advised to check the socket shape used in the country of your destination (see “Main Socket Types in the Major Countries and Regions of the World”) and take an appropriately shaped adapter plug with you.

The socket shape does not affect battery charging.

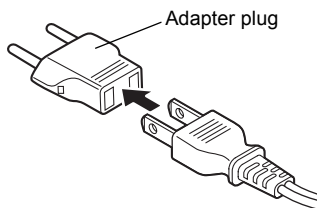

Caution

- Use of battery charger components other than those specified for your camera may result in damage to the battery and improper camera operation.
- Unplug the adapter plug from the power outlet when the battery charger is not in use.

Type	A	B	BF	C	S
Shape					
Adapter plug	—				

Main Socket Types in the Major Countries and Regions of the World

		A	B	BF	C	S
North America	U.S.A., Canada	○				
Europe, Former Soviet Union	Iceland, Ireland, Italy, Ukraine, Austria, Netherlands, Kazakhstan, Greece, Sweden, Denmark, Germany, Norway, Hungary, Finland, France, Belarus, Belgium, Rumania, Russia				○	
	U.K.		○	○		
	Spain	○			○	
	Switzerland, Poland, Portugal		○		○	
Asia	Japan, Taiwan	○				
	Sri Lanka, Maldives		○			
	Nepal, Bangladesh, Mongolia				○	
	Vietnam	○			○	
	India, Indonesia, Pakistan, Macau		○		○	
	Thailand	○		○	○	
	Korea	○	○		○	
	Philippines	○			○	○
	Singapore, Hong Kong		○	○		
	China	○	○	○	○	○
Malaysia		○	○	○		
Oceania	Australia, Tonga, New Zealand, Fiji					○
	Guam	○				
	Tahiti				○	
Central and South America	Colombia, Jamaica, Haiti, Panama, Bahamas, Puerto Rico, Venezuela, Mexico	○				
	Brazil, Peru	○			○	
	Chile		○		○	
	Argentina			○	○	○
Middle East	Israel, Iran				○	
	Kuwait		○		○	
	Jordan		○	○		
Africa	Canary Islands, Guinea, Mozambique, Morocco				○	
	Kenya, South Africa		○		○	
	Algeria	○	○	○		
	Egypt		○	○	○	
	Zambia, Tanzania		○	○		

Using the AC Adapter

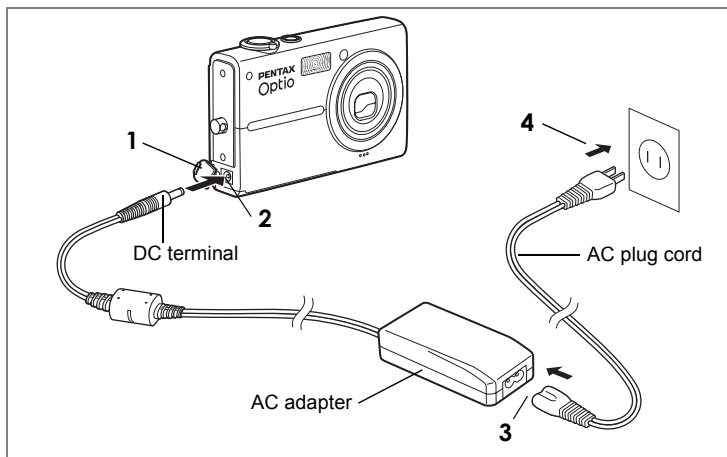

The optional AC adapter kit K-AC7 is recommended when the camera will be used with AV or PC equipment and will be on for long periods of time.

- 1** Make sure that the camera is turned off before opening the DC input terminal cover.
- 2** Connect the DC terminal of the AC adapter to the DC input terminal on the camera.
- 3** Connect the AC plug cord to the AC adapter.
- 4** Plug the AC plug cord into a power outlet.



Caution

- Make sure the camera is turned off before connecting or disconnecting the AC adapter.
- Make sure the AC plug cord and the power cord connecting the AC adapter to the camera are inserted securely. Data may be lost if either becomes disconnected while data is being recorded on the SD Memory Card or the built-in memory.
- Use the AC adapter with due care to avoid fire or electric shock.
- Be sure to read "USING YOUR CAMERA SAFELY" (p.7) before using the AC adapter.
- Be sure to read the operation manual accompanying the AC adapter kit K-AC7 before using it.
- The battery inside the camera does not charge when the AC adapter is connected to the camera.

Optional Accessories

A number of dedicated accessories are available for this camera.

AC adapter kit K-AC7 (AC adapter D-AC7, AC Plug cord D-CO2)

Battery charger kit D-BC8 (*)

(Battery charger D-BC8, AC Plug cord D-CO2)

The ending of the AC plug cord D-CO2 (*) differs depending on the country.

Rechargeable lithium-ion battery D-LI 8 (*)

USB cable I-USB17 (*)

AV cable I-AVC7 (*)

Strap O-ST20 (*)

Leather strap O-ST24

Strap O-ST8

Sports strap O-ST30

Remote control E (Zoom function)

Remote control F

Camera case O-CC45

Products marked with an asterisk (*) are the same as those supplied with the camera.

Messages

Messages such as the following may appear on the LCD monitor during camera operation.

Battery depleted	The battery is exhausted. Charge the battery using the battery charger (p.14).
Memory card full	The SD Memory Card is full and no more images or sound files can be saved. Insert a new SD Memory Card or delete unwanted images or sound files (p.17, p.88). Change the picture size or quality or both and try again (p.49, p.93).
Built-in memory full	The built-in memory is full and no more image or sound files can be saved. Insert an SD Memory Card or delete unwanted images or sound files (p.17, p.88). Change the picture size or quality or both and try again (p.49, p.93).
Memory card error	Shooting and playback are impossible due to a problem with the SD Memory Card. However, you may be able to display or copy already recorded images on the card using a PC.
Card not formatted	The SD Memory Card you have inserted is unformatted or has been formatted on a computer or other device that is not compatible with this camera (p.120).
Card locked	The SD Memory Card is write-protected (p.19).
Compression error	Compression of the image you captured has failed. Change the quality/size and try again (p.49, p.93).
No image/sound	There are no image/sound files on the SD Memory Card to play back.
Deleting	Appears when deleting an image or sound file.
Camera cannot play this image and sound	The image or sound is in a format not supported by the camera. You may be able to play it back on another brand of camera or on your computer.
Image folder could not be created	The largest file number (9999) has been assigned to an image or sound file in the largest folder number (999) and no more image or sound files can be saved. Insert a new SD Memory Card or format the card (p.17, p.120).
Image/sound cannot be created	The maximum number (5000) of images or sound files has been recorded, and no more pictures or sound files can be recorded. Insert a new SD Memory Card or format the card (p.17, p.120).









Protected	The image or sound file you are trying to delete is protected.
Data being recorded	Appears when you try to switch to Playback mode while an image is still being recorded, or when the protect setting or DPOF setting is being changed. It disappears after the image is recorded or the setting is changed.
Data being processed	Appears when the camera takes more than five seconds to display an image due to image processing, or when the SD Memory Card or built-in memory is being formatted.
This image/sound cannot be resized.	Appears when you try to resize an image or sound file that cannot be resized.
This image/sound cannot be trimmed.	Appears when you try to trim an image or sound file that cannot be trimmed.











Messages such as the following may appear on the LCD monitor when using the PictBridge function.

No paper in the printer	The printer is out of paper.
No ink in the printer	The printer is out of ink.
Printer error	An error message has been sent from the printer.
Data error	A data error message has been sent from the printer.
Paper stuck in the printer	The printer has a paper jam.

Troubleshooting

Problem	Cause	Solution
Camera will not turn on	Battery is not installed	Check if a battery is installed. If not, install battery (p.15).
	Battery is installed incorrectly	Check orientation of battery. Reinsert battery (p.15).
	The battery is exhausted	Charge the battery (p.14).
	The battery performance has temporarily deteriorated because it is too cold	Warm up the battery by placing it in a pocket where it can come in contact with body heat.
No image on LCD monitor	Camera is turned off	Turn the camera on (p.20).
	Camera is connected to a computer	The LCD monitor turns off when the camera is connected to a computer.
	Camera is connected to a TV	The LCD monitor turns off when the camera is connected to a TV.
	Display mode is set to Off	Touch the LCD monitor to change the display mode setting (p.40).
	Power Saving function has activated	Deactivate by pressing the shutter release button halfway in Capture mode or by touching the LCD monitor in Playback mode.
	Image is displayed but is hard to see	Increase the brightness of the LCD monitor (p.132).
Shutter will not release	Flash is charging	Pictures cannot be taken while the flash is charging. Wait until charging is finished.
	No available space on SD Memory Card or in the built-in memory	Insert SD Memory Card with available space or delete unwanted files (p.17, p.88). Change the picture size or quality or both and try again (p.49, p.93).
	Recording	Wait until recording is finished.

Problem	Cause	Solution
Subject is not in focus	Subject is difficult to focus on with autofocus	Lock focus on another object located at the same distance (press shutter release button halfway), then compose picture and press shutter release button fully, or use Manual Focus mode (p.64).
	Subject is not in focusing area	Position subject in focus frame in middle of LCD monitor. If the subject is outside the focusing area, aim the camera at the subject and lock the focus (press shutter release button halfway), then compose picture and press the shutter release button fully.
	Subject is too close	Set focus mode to  (Macro) (p.63).
	Focus mode is set to  (Macro)	Subjects at a distance of 40 cm or greater will be out of focus if taken with the focus mode set to  (Macro) (p.63).
	Subject is too dark to focus on	Set auxiliary AF light to On (p.66).
Flash does not discharge	Flash mode is set to  (Flash Off)	Set to  (Auto) or  (Flash On) (p.56).
	The shooting mode is set to  (Movie), the drive mode is set to  (Cont. Shooting), or the focus mode is set to  (Infinity)	Switch to a different mode.
Subject is blurred	Camera moved when taking a picture	Use a tripod and the self-timer or remote control function when taking a picture (p.62).
	Subject moved when taking a picture	Use flash or set a higher ISO sensitivity to increase the shutter speed (p.62).
Colors in picture are not accurate	Camera is unable to automatically adjust white balance, or setting is incorrect	Check the white balance setting (p.58).

Problem	Cause	Solution
Picture is too dark	Flash mode is set to  (Flash Off)	Set to  (Auto) or  (Flash On) (p.56).
	Subject is beyond the flash range	Take picture within range of flash (p.56).
	Camera is unable to correctly adjust exposure	Adjust EV setting toward  (p.53).
	Subject is backlit	Use spot AE metering on the subject to obtain proper exposure (p.55).
Picture is too light	Flash discharged	Set the flash mode to  (Flash Off) to turn off the flash, or set it to  (Soft) to lower the intensity of the flash (p.56).
	Camera is unable to correctly adjust exposure	Adjust EV setting toward  (p.53).
Image or sound file cannot be deleted	SD Memory Card is write-protected	Unlock the SD Memory Card write-protection switch (p.19).
	Image or sound file is protected	Cancel the protection setting of the image or sound file (p.91).
Cannot play back image or sound file in built-in memory	SD Memory Card is inserted	Remove the SD Memory Card (p.18).
Functions return to their original settings when camera is turned off	Memory is set to Off	Set Memory to On, to save the settings of your functions when the camera is turned off (p.38).
Wrong date is displayed on images and/or sound files	Date and time are not set	Set the date and time. The date and time are not set at the time of purchase (p.21).
	Camera was stored with exhausted battery	The date and time settings are canceled when the camera is stored for approximately one day with an exhausted battery. Reset the date and time (p.121).
USB connection to computer does not work properly	USB connection mode is set to  (PictBridge)	Change the USB connection mode to  (PC) (p.130).
USB connection to printer does not work properly	USB connection mode is set to  (PC)	Change the USB connection mode to  (PictBridge) (p.130).
Camera images are not displayed on TV	Improper cable connections, no power, incorrect TV format chosen	Make sure video cable is connected to proper input on TV, that both camera and TV are turned on, and that the correct video format is selected (p.86).

Memo

Main Specifications

Type	Fully automatic compact digital still camera with built-in zoom lens	
Effective Pixels	6.0 megapixels	
Sensor	6.36 megapixels (total pixels) 1/2.5 inch interline transfer CCD with a primary color filter	
Recorded Pixels	Picture	6M (2816×2112 pixels), 5M (2592×1944 pixels) 4M (2304×1728 pixels), 3M (2048×1536 pixels) 2M (1600×1200 pixels), 640 (640×480 pixels)
	Movie	640 (640×480 pixels), 320 (320×240 pixels)
Sensitivity	Auto, Manual (80/160/320/400: Standard Output Sensitivity)	
File Format	Picture	JPEG (Exif 2.2), DCF, DPOF, PictBridge, PRINT Image Matching III
	Movie	AVI (Motion JPEG), streaming video, approx. 30fps/15fps, PCM system, monaural sound
	Sound	Voice memo, voice recording: WAVE (PCM) system, monaural
Quality Level	Picture	★★★ (Best), ★★ (Better), ★ (Good)
	Movie	★★★ (Best), ★★ (Better), ★ (Good)
Storage Medium	Built-in memory (approx. 12 MB), SD Memory Card	

Approximate Image Storage Capacity and Recording Time

Picture

	★★★ (Best)		★★ (Better)		★ (Good)	
	Built-in Memory	128 MB	Built-in Memory	128 MB	Built-in Memory	128 MB
6M 2816×2112	3 pictures	35 pictures	7 pictures	73 pictures	10 pictures	103 pictures
5M 2592×1944	4 pictures	42 pictures	8 pictures	82 pictures	12 pictures	124 pictures
4M 2304×1728	5 pictures	53 pictures	10 pictures	103 pictures	15 pictures	155 pictures
3M 2048×1536	6 pictures	68 pictures	12 pictures	130 pictures	18 pictures	190 pictures
2M 1600×1200	10 pictures	103 pictures	17 pictures	177 pictures	26 pictures	275 pictures
640 640×480	39 pictures	414 pictures	66 pictures	690 pictures	92 pictures	966 pictures

Movie/Sound

		30fps		15fps		Sound	
		Built-in Memory	128 MB	Built-in Memory	128 MB	Built-in Memory	128 MB
<div style="border: 1px solid black; padding: 2px; display: inline-block;">640</div> 640×480	★★★	4 sec.	48 sec.	9 sec.	1 min. 36 sec.	12 min. 47 sec.	2 hr. 12 min. 22 sec.
	★★	6 sec.	1 min. 9 sec.	13 sec.	2 min. 17 sec.		
	★	10 sec.	1 min. 50 sec.	21 sec.	3 min. 40 sec.		
<div style="border: 1px solid black; padding: 2px; display: inline-block;">320</div> 320×240	★★★	18 sec.	3 min. 12 sec.	36 sec.	6 min. 24 sec.		
	★★	26 sec.	4 min. 35 sec.	52 sec.	9 min. 7 sec.		
	★	42 sec.	7 min. 19 sec.	1 min. 23 sec.	14 min. 32 sec.		

White Balance Auto, Daylight, Shade, Tungsten Light, Fluorescent Light, Manual

Lens Focal Length 6.2 mm - 18.6 mm
(equivalent to 37.5 mm - 112.5 mm in 35 mm format)

Aperture f/2.7 - f/5.2

Lens Composition 6 elements in 5 groups (two aspherical elements)

Zoom Type Electrically driven

Picture Range Approx. 148 mm × 111 mm (screen is filled) (Macro mode)

Digital Zoom Capture Mode Max. 4× (combines with 3× optical zoom to give zoom magnification equivalent to 12×)

LCD Monitor 3.0-inch TFT color LCD monitor (touch display) with backlight and brightness adjustment, approx. 230,000 pixels

Playback Functions Single-frame, 9-frame index, magnify (max. 12×, scroll), rotating, sound playback, slideshow, movie playback and editing (saving as still image), histogram display, image/sound copy, digital filter (Soft, Illustration, Broader or More slender, Special Effect), brightness filter, color filter (Black & White, Sepia, Color (8 variations), B&W+Red, B&W+Blue, B&W+Green), trimming, resizing, framing, red-eye compensation, My Drawing (Line, Stamp, Crop, My Stamp, Erase), voice memo, protect, DPOF, start-up screen

Focus Modes Autofocus, Macro, Pan Focus, Infinity, Manual Focus

Focusing System	Type	TTL contrast detection system by sensor 5-point autofocus (multiple/spot changeable)
	Still Picture Focusing Range (from lens front)	Normal : Approx. 0.4 m - ∞ (full zoom range) Macro : Approx. 0.15 m - 0.5 m (full wide-angle setting) Pan Focus : Approx. 1.2 m - ∞ (full wide-angle setting) Approx. 4.8 m - ∞ (full telephoto setting) Landscape : ∞ (full zoom range) Manual focus: Approx. 0.15 m - ∞ (full wide-angle setting) Approx. 0.4 m - ∞ (except for full wide-angle setting)
Movie Focusing Range (from lens front)	Normal	: Approx. 0.15 m - ∞ (full wide-angle setting) Approx. 0.4 m - ∞ (except for full wide-angle setting)
	Macro	: Approx. 0.15 m - 0.5 m (full wide-angle setting)
Focus Lock	Pan Focus	: Approx. 0.7 m - ∞ (full wide-angle setting) Approx. 2.7 m - ∞ (full telephoto setting)
	Landscape	: ∞ (full zoom range)
Manual focus		: Approx. 0.15 m - ∞ (full wide-angle setting) Approx. 0.4 m - ∞ (except for full wide-angle setting)
Exposure Mechanism	AE metering	TTL metering by sensor (multi-segment, center-weighted, spot)
	EV Compensation	± 2 EV (can be set in 1/3 EV steps)
Shooting Modes		Program, Night Scene, Movie, Voice Recording, Landscape, Flower, Portrait, Surf & Snow, Sport, Pet, Food, Frame Composite
Movie	Continuous Recording Time	Approx. 1 second, minimum, or until built-in memory or SD memory card is full.
Shutter	Type	Electronic/mechanical shutter
	Speed	Approx. 1/2000 sec. - 4 sec.

Flash	Type	Auto flash with red-eye reduction function
	Flash Modes	Auto (at low illumination), Flash Off, Flash On, Auto+Red-eye, Flash On+Red-eye, Soft Flash (Slow synchronization is possible only in Night Scene mode)
	Effective Range	Full wide-angle setting: Approx. 0.15 m - 4.5 m (Standard Output Sensitivity: in Auto condition) Full telephoto setting: Approx. 0.4 m - 2.5 m (Standard Output Sensitivity: in Auto condition)
Drive Modes	Single-frame, Self-timer (approx. 10 sec., approx. 2 sec.), Continuous, Remote Control (approx. 3 sec., on-demand)	
Self-timer	Electronic control type, control time: approx. 10 sec., approx. 2 sec.	
Remote Control	PENTAX Remote control E/F (optional) Zooming is possible with Remote control E.	
Time Function	World Time	71 cities (28 time zones)
Power Supply	Rechargeable lithium-ion battery D-LI 8, AC adapter kit (optional)	
Battery Life	Number of Recordable Images	* Recording capacity shows approximate number of shots recorded during CIPA-compliant testing (with LCD monitor on, flash used for 50% of the shots, and at an ambient temperature of 23°C). Actual performance may vary depending on operating conditions.
	Playback Time	* According to the result of PENTAX in-house testing.
Max. Charging Time	Approx. 100 min.	
In/Out Port	PC (USB 2.0, High-Speed compatible)/AV terminal, DC input terminal	
Video Output Format	NTSC/PAL (monaural)	
PictBridge	Printer	PictBridge-compatible printer
	Print Modes	Print One, Print All, DPOF AUTOPRINT
	Paper Size	Card, L, 2L, Postcard, 100 mm×150 mm, 4"×6", 8"×10", Letter, 11"×17", A4, A3, printer setting
	Paper Type	★★★, ★★, ★, printer setting
	Quality	★★★, ★★, ★, printer setting
	Border Status	With/without, printer setting
Size	95 (W) × 58.5 (H) × 19.5 (D) mm (excluding operating or protruding parts)	
Weight	135 g (excluding battery and SD Memory Card)	
Weight When Shooting	155 g (including battery and SD Memory Card)	
Accessories	Rechargeable lithium-ion battery, battery charger, AC plug cord, USB cable, AV cable, software (CD-ROM), strap, stylus, operating manual	

Information on disposal for users



1. In the European Union

If your product is marked with this symbol, it means that used electrical/electronic products should not be mixed with general household waste. There exists a separate collection system for these products.

Used electric/electronic equipment must be treated separately and in accordance with legislation that requires proper treatment, recovery and recycling of these products. Following the implementation by member states, private households within the EU states may return their used electrical/electronic equipments to designated collection facilities free of charge*. In some countries your local retailer may also take back your old product free of charge if you purchase a similar new one.

* Please contact your local authority for further details.

By disposing of this product correctly you will help ensure that the waste undergoes the necessary treatment, recovery and recycling and thus prevent potential negative effects on the environment and human health which could otherwise arise due to inappropriate waste handling.

2. In other countries outside the EU

If you wish to discard this product, please contact your local authorities and ask for the correct method of disposal.

For Switzerland: Used electrical/electronic equipment can be returned free of charge to the dealer, even when you don't purchase a new product. Further collection facilities are listed on the home page of www.swico.ch or www.sens.ch.

WARRANTY POLICY

All PENTAX cameras purchased through authorized bona fide photographic distribution channels are guaranteed against defects of material or workmanship for a period of twelve months from date of purchase. Service will be rendered, and defective parts will be replaced without cost to you within that period, provided the equipment does not show evidence of impact, sand or liquid damage, mishandling, tampering, battery or chemical corrosion, operation contrary to operating instructions, or modification by an unauthorized repair shop. The manufacturer or its authorized representatives shall not be liable for any repair or alterations except those made with its written consent and shall not be liable for damages from delay or loss of use or from other indirect or consequential damages of any kind, whether caused by defective material or workmanship or otherwise; and it is expressly agreed that the liability of the manufacturer or its representatives under all guarantees or warranties, whether expressed or implied, is strictly limited to the replacement of parts as hereinbefore provided. No refunds will be made on repairs by non-authorized PENTAX service facilities.

Procedure During 12-month Warranty Period

Any PENTAX which proves defective during the 12-month warranty period should be returned to the dealer from whom you purchased the equipment or to the manufacturer. If there is no representative of the manufacturer in your country, send the equipment to the manufacturer, with postage prepaid. In this case, it will take a considerable length of time before the equipment can be returned to you owing to the complicated customs procedures required. If the equipment is covered by warranty, repairs will be made and parts replaced free of charge, and the equipment will be returned to you upon completion of servicing. If the equipment is not covered by warranty, regular charges of the manufacturer or of its representatives will apply. Shipping charges are to be borne by the owner. If your PENTAX was purchased outside of the country where you wish to have it serviced during the warranty period, regular handling and servicing fees may be charged by the manufacturer's representatives in that country. Notwithstanding this, your PENTAX returned to the manufacturer will be serviced free of charge according to this procedure and warranty policy. In any case, however, shipping charges and customs clearance fees to be borne by the sender. To prove the date of your purchase when required, please keep the receipt or bills covering the purchase of your equipment for at least a year. Before sending your equipment for servicing, please make sure that you are sending it to the manufacturer's authorized representatives or their approved repair shops, unless you are sending it directly to the manufacturer. Always obtain a quotation for the service charge, and only after you accept the quoted service charge, instruct the service station to proceed with the servicing.

- **This warranty policy does not affect the customer's statutory rights.**
- **The local warranty policies available from PENTAX distributors in some countries can supersede this warranty policy. Therefore, we recommend that you review the warranty card supplied with your product at the time of purchase, or contact the PENTAX distributor in your country for more information and to receive a copy of the warranty policy.**



The CE Mark is a Directive conformity mark of the European Union.

For customers in USA

STATEMENT OF FCC COMPLIANCE

This device complies with Part 15 of the FCC Rules. Operation is subject to the following two conditions: (1) This device may not cause harmful interference, and (2) this device must accept any interference received, including interference that may cause undesired operation.

Changes or modifications not approved by the party responsible for compliance could void the user's authority to operate the equipment.

This equipment has been tested and found to comply with the limits for a Class B digital device, pursuant to part 15 of the FCC Rules.

These limits are designed to provide reasonable protection against harmful interference in a residential installation. This equipment generates, uses and can radiate frequency energy and, if not installed and used in accordance with the instructions, may cause harmful interference to radio communications. However, there is no guarantee that interference will not occur in a particular installation.

If this equipment does cause harmful interference to radio or television reception, which can be determined by turning the equipment off and on, the user is encouraged to try to correct the interference by one or more of the following measures:

- Reorient or relocate the receiving antenna.
Increase the separation between the equipment and receiver.
Connect the equipment into an outlet on a circuit different from that to which the receiver is connected.
- Consult the dealer or an experienced radio/TV technician for help.

For customers in Canada

This Class B digital apparatus meets all requirements of the Canadian Interference - Causing Equipment Regulations.

Pour les utilisateurs au Canada

Cet appareil numérique de la classe B respecte toutes les exigences du Règlement sur le matériel brouilleur du Canada.

Declaration of Conformity
According to 47CFR, Parts 2 and 15 for
Class B Personal Computers and Peripherals

We: PENTAX Imaging Company
A Division of PENTAX of America, Inc.

















Located at: 600 12th Street, Suite 300
Golden, Colorado 80401 U.S.A.
Phone: 303-799-8000 FAX: 303-790-1131

Declare under sole responsibility that the product identified herein complies with 47CFR Parts 2 and 15 of the FCC rules as a Class B digital device. Each product marketed is identical to the representative unit tested and found to be compliant with the standards. Records maintained continue to reflect the equipment being produced can be expected to be within the variation accepted, due to quantity production and testing on the statistical basis as required by 47CFR §2.909. Operation is subject to the following two conditions: (1) This device may not cause harmful interference, and (2) This device must accept any interference received, including interference that may cause undesired operation. The above named party is responsible for ensuring that the equipment complies with the standards of 47CFR §15.101 to §15.109.

Product Name: PENTAX Digital Still Camera
Model Number: Optio T10
Contact person: Customer Service Manager
Date and Place: February, 2006, Colorado

Index

Symbols

	Tele	45
	Wide	45
	Magnify	79
	Nine-image display	80
	button	25
	Movie	28
	Voice Recording	30
	Program	42
	Night Scene	42, 44
	Landscape	42
	Flower	42
	Portrait	42
	Surf & Snow	42
	Sport	42
	Pet	42, 44
	Food	42
	Frame Composite	42

A

AC adapter	139
AE Metering	55
Auto Power Off	134
Aux.AF Light	66

B

Battery	14
Blurring of subject	62
Bright Filter	102
Broader or More slender (Digital Filter)	103

C

Camera shake	62
Capture Palette	43
Capture Toolbar	34, 35
Center-weighted metering	55
Charging the battery abroad	137
Checking the memory card	20
Color Filter	101
Computer	130
Continuous Shooting	72
Contrast	60
Copy	108

D

Date and Time	21, 121
Daylight (White Balance)	58
Delete	88
Depth of field	62
Digital Filters	103
Digital Zoom	46
DPOF printing	116
DPOF settings	110

F

Flash	56
Flash Off (Flash)	56
Flash On (Flash)	56
Fluores. Light (White Balance)	58
Focus	61
Focus Limiter	66

- Focus Modes 63
- Focusing Area 65
- Folder Name 129
- Format 120
- Frame Composite 99
- Frame Rate 49
- Framing pictures 47
- G**
- Guide Display 135
- H**
- Histogram 54
- I**
- Illustration (Digital Filter) 103
- Index (Recording Sounds) 31
- Infinity (Focus Mode) 63
- Initial Settings 21
- Instant Review 73
- L**
- Language 21, 128
- LCD monitor brightness 132
- M**
- Macro (Focus Mode) 63
- Magnify 79
- Manual (White Balance) 58
- Manual focus 64
- Memory 38
- Menu 34, 35, 118
- MENU** button 34, 118
- Movie 28, 82
- Multiple (Focusing Area) 65
- Multi-segment metering 55
- My Drawing 95
- N**
- Nine-image Display 80
- NTSC format 131
- O**
- Optional Accessories 141
- P**
- PAL format 131
- Pan Focus 63
- PictBridge 113
- Playback Only mode 78
- Playback Palette 74, 75
- Playback Toolbar 74, 75
- Playing back sounds 83
- Power Saving 133
- Power switch 20
- Press fully
(shutter release button) 25
- Press halfway
(shutter release button) 24
- Print 32
- Printer 130
- Protect 91
- Q**
- Quality Level 49
- R**
- Recorded Pixels 49
- Recording Capacity 16, 50
- Red-eye Compensation 104
- Red-eye Compensation
(Flash) 56
- Remote Control 70
- Reset 136

- Resize 93
 Rotating 78
- S**
- Saturation 60
 Saving as a still picture
 (movie) 107
 Saving by date 129
 SD Memory Card 17
 Self-timer 69
 Sensitivity 67
 Setting the Exposure
 (EV Compensation) 53
 Shade (White Balance) 58
 Sharpness 60
 Shooting Information 40, 76
 Shooting Mode 42
 Shutter release button 24, 25
 Slideshow 84
 Soft (Digital Filter) 103
 Sound 30, 119, 123
 Spot (Focusing Area) 65
 Spot AE metering 55
 Stamp 95
 Start-up screen 106
 Strap 13
 Stylus 13
- T**
- Trimming 94
 Tungsten Light
 (White Balance) 58
 TV 86
- U**
- USB Connection 130
- V**
- Video Output Format 131
 Voice Memo 81, 89, 105
- W**
- White Balance 58
 World Time 125
- Z**
- Zoom 45

Memo

- PENTAX Corporation** 2-36-9, Maeno-cho, Itabashi-ku, Tokyo 174-8639, JAPAN
(<http://www.pentax.co.jp/>)
- PENTAX Europe GmbH
(European Headquarters)** Julius-Vosseler-Strasse, 104, 22527 Hamburg, GERMANY
(HQ - <http://www.pentaxeurope.com>)
(Germany - <http://www.pentax.de>)
- PENTAX U.K. Limited** PENTAX House, Heron Drive, Langley, Slough, Berks
SL3 8PN, U.K.
(<http://www.pentax.co.uk>)
- PENTAX France S.A.S.** 112 Quai de Bezons, B.P. 204, 95106 Argenteuil Cedex, FRANCE
(<http://www.pentax.fr>)
- PENTAX Benelux B.V.** (for Netherlands)
Spinveld 25, 4815 HR Breda, NETHERLANDS
(<http://www.pentax.nl>)
(for Belgium & Luxembourg)
Weiveldlaan 3-5, 1930 Zaventem, BELGIUM
(<http://www.pentax.be>)
- PENTAX (Schweiz) AG** Widenholzstrasse 1 Postfach 367 8305
Dietlikon, SWITZERLAND
(<http://www.pentax.ch>)
- PENTAX Scandinavia AB** P.O. Box 650, 75127 Uppsala, SWEDEN
(<http://www.pentax.se>)
- PENTAX Imaging Company**
A Division of PENTAX of America, Inc.
(Headquarters)
600 12th Street, Suite 300 Golden, Colorado 80401, U.S.A.
(PENTAX Service Department)
12000 Zuni Street, Suite 100B
Westminster, Colorado 80234, U.S.A.
(<http://www.pentaximaging.com>)
- PENTAX Canada Inc.** 1770 Argentia Road Mississauga, Ontario L5N 3S7, CANADA
(<http://www.pentax.ca>)



<http://www.pentax.co.jp/english>

- Specifications and external dimensions are subject to change without notice.