

PC Connection Manual

You can transfer images and movies captured with a digital camera to your computer and then organize, display, edit, print, and share them by installing the software recorded on the provided CD-ROM to your computer and connecting your digital camera to your computer with the USB cable. This section explains how to install the provided software "ACDSee for PENTAX" and the other necessary preparations for enjoying your digital camera pictures and movies on your computer.

Software Provided

Windows

- ACDSee for PENTAX 2.0 (Image viewing/editing software)
- ACD photostitcher (Panorama image editing software)
- FotoSlate 3.0 (Image layout and printing software)
- ACD Showtime! for PENTAX (Movie editing software)
- QuickTime 6
- DirectX 9.0

Macintosh

- ACDSee for PENTAX (Image viewing software)
- ACD photostitcher (Panorama image editing software)

Caution You are recommended to use the AC adapter D-AC5 (optional) connected to a power outlet when connecting the camera to a computer. If the battery runs out of power while images are being transmitted to the computer, the image data may be lost or damaged. When using the AC adapter, make sure that the DC terminal is properly connected to the camera.

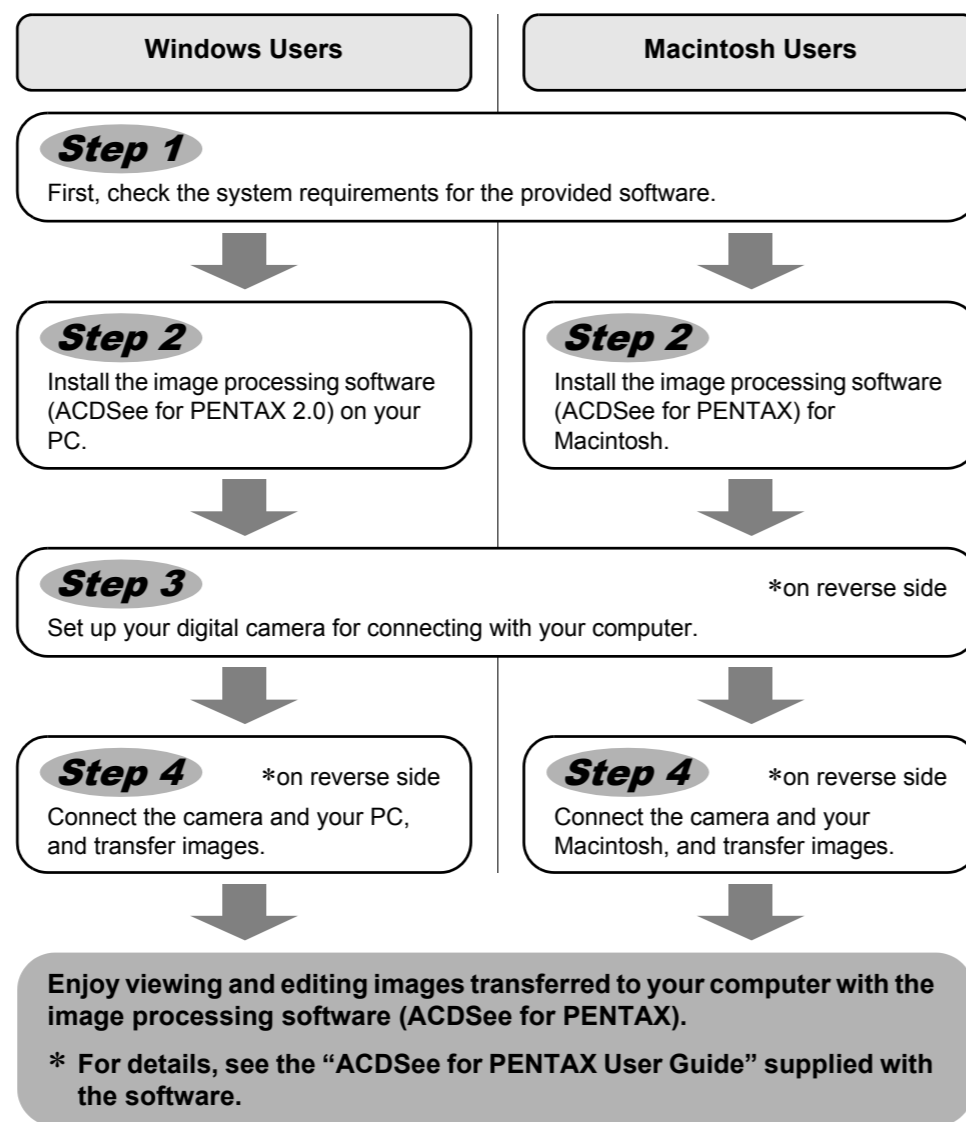

Windows, Macintosh Step 1

System Requirements

Windows System Requirements

Caution The software cannot be used on Windows 95.

• USB connection

- OS : Windows Me/2000/XP (An SD memory card reader is necessary if using Windows 98/98SE, because the USB driver is not compatible with Windows 98/98SE.)
- USB port must be standard equipment

• Application Software

<ACDSee for PENTAX 2.0, ACD photostitcher and FotoSlate 3.0>

(9 languages: English, French, German, Spanish, Italian, Russian, Chinese [traditional and simplified], Korean, Japanese)

- OS : Windows 98SE/Me/NT/2000/XP
- CPU : Pentium or higher recommended
- Memory : 64MB minimum
- Hard Disk space : 40MB minimum
- Internet Explorer 5.0 or later

* Some formats require viewing with QuickTime 6 or later, DirectX 9.0 or later and Windows Media Player 7.1 or later.

* To install ACDSee for PENTAX 2.0, Windows Installer Service Version 2.0 is required.

* ACD Showtime! for PENTAX is also installed when performing standard installation of ACDSee for PENTAX 2.0 (However, ACD Showtime! for PENTAX cannot be used if system requirements are not met.)

* Operation is not guaranteed on all PCs meeting the system requirements.

<ACD Showtime! for PENTAX>

(6 languages: English, French, German, Spanish, Italian, Japanese)

- OS : Windows 98SE/Me/NT/2000/XP
- CPU : Pentium III 500MHz or higher (Pentium4 2.0GHz or higher recommended)

- Memory : 128MB minimum (512MB or higher recommended)
- Hard Disk space : 50MB minimum
- Internet Explorer 5.0 or later
- QuickTime 6 or later
- Windows Media Player 7.1 or later
- DirectX 9.0 or later

<QuickTime 6>

(8 languages: English, French, German, Spanish, Italian, Chinese [traditional and simplified], Korean, Japanese)

- OS : Windows 98/98SE/Me/NT/2000/XP
- CPU : Pentium or higher recommended
- Memory : 128MB minimum

* QuickTime 6 or later is required to play movies with the provided software ACDSee for PENTAX 2.0 or ACD Showtime! for PENTAX.

The versions of Internet Explorer, Windows Media Player and Windows Installer Service required for use of ACDSee for PENTAX 2.0 and ACD Showtime! for PENTAX are not included in the provided CD-ROM (S-SW32). These can be downloaded from the following sites and installed.

- Internet Explorer
<http://www.microsoft.com/ie>
- Windows Media Player
<http://www.microsoft.com/windows/windowsmedia/>
- Windows Installer Service
<http://support.microsoft.com/default.aspx?scid=kb;EN-US;292539>

Macintosh System Requirements

• USB connection

- OS : Mac OS 9.2/X (Ver. 10.1, 10.2, 10.3)
- USB port must be standard equipment

* Installation of the driver is not necessary.

• Application Software

<ACDSee for PENTAX and ACD photostitcher>

(6 languages: English, French, German, Spanish, Italian, Japanese)

- OS : Mac OS 9.2 or higher (QuickTime 6 or later is required. Or, for Mac OS 9.2, the most recent version of CarbonLib is necessary.)

- CPU : PowerPC 266MHz or higher
- Memory : 8MB minimum
- Hard Disk space : 6MB minimum

* Operation is not guaranteed on all PCs meeting the system requirements.

Windows Step 2

Installing the Software

Installing the Image Processing Software (ACDSee for PENTAX 2.0)

This section describes the procedures for installing ACDSee for PENTAX 2.0, which lets you view and edit images transferred to your PC.

- Caution**
- Windows Media Player 7.1 or later must be installed in your PC to install ACDSee for PENTAX 2.0.
 - When multiple accounts have been setup in Windows 2000 or Windows XP, log on with an account that has administrative rights before installing the software.

- 1 Turn your PC on.
- 2 Insert the CD-ROM (S-SW32) into the CD-ROM drive.

The PENTAX Software Installer screen appears.

- If the PENTAX Software Installer screen does not appear
Display the PENTAX Software Installer screen following the steps below.

- 1) Double-click [My Computer] on the desktop.
- 2) Double-click the [CD-ROM drive (S-SW32)] icon.
- 3) Double-click [Setup.exe].

- 3 You can choose the languages from the displayed screen.

The software selection screen appears.



- 4 Install QuickTime and DirectX.

If QuickTime and DirectX are not installed in your PC, install them before installing ACDSee for PENTAX 2.0. Click [QuickTime™] or [DirectX®]. Leave other settings at default and click [Next] when the Setup screen appears. When installation is completed, the software selection screen reappears.



- 5 Click [ACDSee™].

Follow the on-screen guidance and enter the registration information when the Setup screen appears. Reboot your PC after installation is finished (Other settings are not necessary during installation).



If QuickTime and DirectX are not installed in your PC, a message such as the one shown on the right appears when ACDSee for PENTAX 2.0 is run. Click [Close] and install QuickTime and DirectX from the [PENTAX Software Installer] screen.

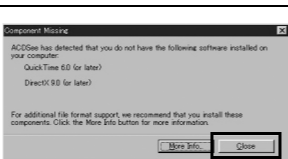

* If QuickTime and DirectX are not installed in your PC, operation of ACDSee for PENTAX 2.0 is not guaranteed.

If your PC is running Windows Media Player earlier than version 7.1, a message such as the one shown on the right may appear during installation.

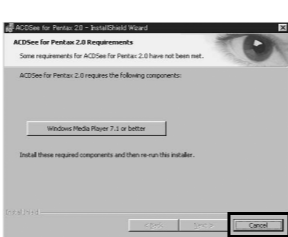

In this case, follow the instructions below to update Windows Media Player before installing the software.

- 1 Cancel installation of ACDSee for PENTAX.
Click [Cancel] and then click [Finish] when the next screen appears.
- 2 Install the latest version of Windows Media Player.
The latest version can be downloaded from the following website.

<http://www.microsoft.com/windows/ie/default.msp>
To guarantee more efficient operation, you are recommended to update Windows from the above website after updating Windows Media Player.

* If your PC is not connected to the Internet, contact your nearest PENTAX customer service center.

memo The panoramic image software "ACD photostitcher", the image layout and printing software "FotoSlate 3.0", and the movie editing software "ACD Showtime! for PENTAX" are also installed when you install all program features of ACDSee for PENTAX 2.0 (complete installation).

Caution Even when you complete the installation the icon of "ACD photostitcher" is not displayed.

Macintosh Step 2

Installing the Software

Installing the Image Processing Software (ACDSee for PENTAX)

This section describes the procedures for installing ACDSee for PENTAX, which lets you view and edit images transferred to your Macintosh.

- 1 Turn your Macintosh on.
- 2 Insert the CD-ROM (S-SW32) in the CD-ROM drive.
- 3 Double-click the CD-ROM (S-SW32) icon.
- 4 Double-click the [Install ACDSee] icon.
The PENTAX Software Installer screen appears. Double-click the [Master Installer] icon to display the PENTAX Software Installer screen.
- 5 You can choose the languages from the displayed screen.



- 6 Click [ACDSee™].
The setup screen appears. Follow the on-screen guidance to input registration information and install the software.

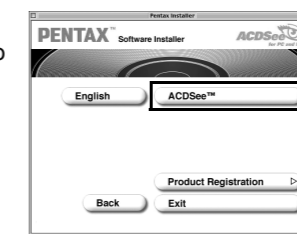

memo "ACD Photosticher", a panorama image editing software, is also installed when you install all program features of ACDSee for PENTAX (complete installation).

If the message [CarbonLib-xxxxx could not be found] appears during installation, You must add the extension file "CarbonLib" to the Extension folder in the System folder in order to install the provided software in Mac OS 9.2. This message appears when this extension file does not exist or when an older version of the file exists. The latest version of the CarbonLib file is available on the Apple website. Download the file and then install it. Apple website: <http://www.apple.com/>
* Contact Apple for detailed information on how to use the CarbonLib file.

Setting Up Your Digital Camera

Setting the USB Connection Mode to [PC]

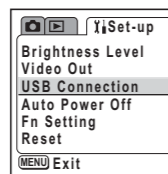
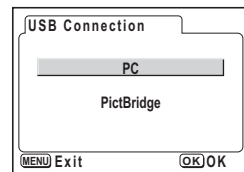
- 1 Press the MENU button.
The [Rec. Mode] menu or the [Playback] menu appears.
 - 2 Press the four-way controller (▶) to display the [i Set-up] menu.
 - 3 Use the four-way controller (▲▼) to select [USB Connection].
 - 4 Press the four-way controller (▶).
- 
- 5 Press the four-way controller (▲▼) to select [PC].
 - 6 Press the OK button twice.
- 

- Do not connect the camera to your PC while [PictBridge] is selected for the USB Connection mode.
- Do not connect the camera to your printer while [PC] is selected for the USB Connection mode.
- If you connect the camera to a PC while the USB connection mode is set to [PictBridge], do the following operation according to your operating system. After completing the procedure, change the connection to [PC] and reconnect the camera and PC again.

OS	Status for USB connection	Follow this instruction
Windows XP	Recognized as PENTAX Optio S55, but cannot read images when trying to acquire them.	Turn off the camera and remove the USB cable from your PC.
Windows 2000	"Found New Hardware Wizard" is displayed.	Click "Cancel", turn off the camera and remove the USB cable from your PC.
Windows Me	"Found New Hardware Wizard" is displayed.	Click "Cancel", turn off the camera and remove the USB cable from your PC.
MacOS 10.3	The i-Photo function starts, but the image cannot be identified.	Turn off the camera and remove the USB cable from your Macintosh computer.
MacOS 10.2	Nothing is displayed on the camera and your Macintosh computer.	Turn off the camera and remove the USB cable from your Macintosh computer.
MacOS 10.1	"Print error" is displayed on the camera's LCD monitor.	Turn off the camera and remove the USB cable from your Macintosh computer.
MacOS 9.2	The message "Software needed for the USB device "Unnamed device" is not available. Would you like to look for the software on the internet?" appears on your Macintosh computer.	Click "Cancel", turn off the camera and remove the USB cable from your Macintosh computer.

For Windows user
go to **Windows Step 4**

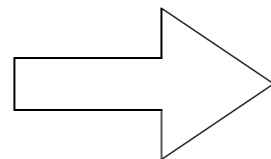

For Macintosh user
go to **Macintosh Step 4**

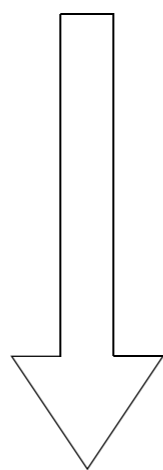

Transferring Images to a Windows PC

When the digital camera is connected to your Windows PC and the camera is turned on, the PC automatically recognizes the camera and begins transferring images.

If the digital camera is connected to your PC in [PictBridge] USB Connection mode, the images cannot be transferred. Disconnect the USB cable from your camera and PC, follow the instructions in "Setting Up Your Digital Camera" to set the USB Connection mode to [PC], and then reconnect the USB cable.

Connecting the Camera and PC

- 1 Turn your PC on.
- 2 With your camera turned off, connect to your PC using the USB cable.
If there is no SD Memory Card in the camera, the images stored in the built-in memory will be transmitted to your PC.

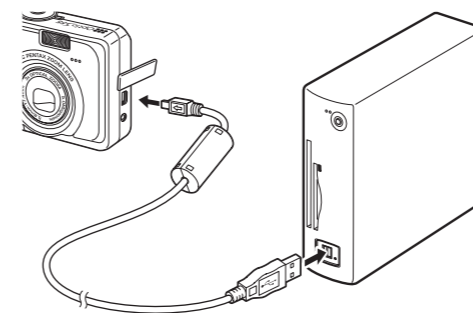

- 3 Turn your camera on.
The Device Detector screen appears automatically. If the Device Detector screen does not appear, display and copy the images following the steps in "When the Device Detector screen does not appear".

When the camera is connected to a PC with the USB cable, the power indicator blinks to indicate that the camera is communicating with the PC.

Transferring Images

- 4 Confirm that [Acquire images from the device with ACDSee] is checked and click [OK].

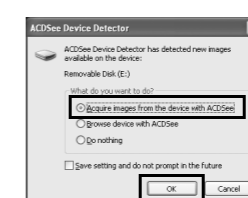

- 5 Click [Next].



- 6 Select an image to copy and click [Next].

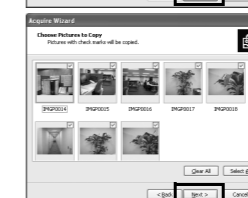

- 7 Specify the name and save destination of the image, and click [Next].

The image is copied to the PC.

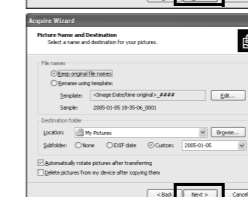

- 8 Click [Finish].
The ACDSee for PENTAX 2.0 Browser starts.



The first time ACDSee for PENTAX 2.0 is run, "ACDSee has detected that you do not have the following software installed on your computer: Ghostscript 7.0 (or later)" may appear in the [Components missing] dialog box. If you will only display or edit images inside the digital camera, it is not necessary for Ghostscript 7.0 to support ACDSee for PENTAX 2.0. Click [Close] to close the message window.

When the Device Detector screen does not appear

- 4 Double-click the [ACDSee for PENTAX 2.0] icon on the desktop.

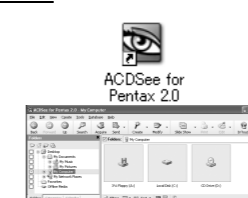

- 5 Double-click [My Computer].



- 6 Double-click [Removable Disk].

If the SD Memory Card has a volume label, the volume label name appears instead of [Removable Disk]. A new unformatted SD Memory Card may show the manufacturer name or model number.

- 7 Double-click the [DCIM] folder.
Images are stored in folder [xxxPENTX], where "xxx" is a three-digit folder number.

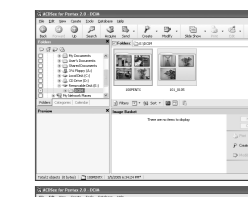

- 8 Select the folders you want to copy to the PC.
Hold the [Ctrl] key on the keyboard while clicking on the folders in which the images you want to copy are stored.



- 9 Select [Copy To Folder...] from the [Edit] menu.
The Copy Files screen appears.



- 10 Specify the destination folder.

- 11 Click [OK].
The image is copied to the PC.

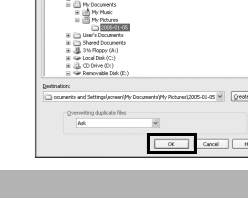

Disconnecting the Camera from Your PC

Windows XP

- 1 Double-click the [Safely Remove Hardware] icon in the task bar.
The Safely Remove Hardware screen appears.
- 2 Select [USB Mass Storage Device] and click [Stop].
The Stop a Hardware device screen appears.

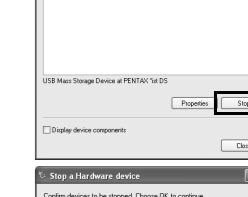

- 3 Select [USB Mass Storage Device] and click [OK].
A message appears indicating that the hardware can be safely removed.



- 4 Disconnect the USB cable from your PC and the camera.

Windows 2000/Me

- 1 Double-click the [Unplug or eject hardware] icon in the task bar.
The Unplug or Eject Hardware screen appears.
- 2 Select [USB Mass Storage Device] and click [Stop].
The Stop a Hardware device screen appears.

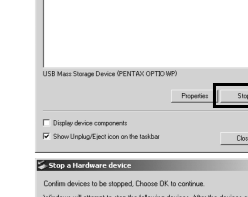
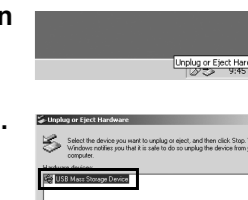

- 3 Select [USB Mass Storage Device] and click [OK].
A message appears indicating that the hardware can be safely removed.

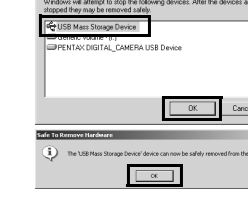

- 4 Click [OK].
- 5 Disconnect the USB cable from your PC and the camera.

If the camera (removable disk) is being used by an application such as ACDSee for PENTAX 2.0, the camera cannot be disconnected until the application is closed.

Transferring Images to a Macintosh

Connecting the Camera and Macintosh

- 1 Turn your Macintosh on.
- 2 With your camera turned off, connect to your Macintosh using the USB cable.
If there is no SD Memory Card in the camera, the images stored in the built-in memory will be transmitted to your Macintosh.

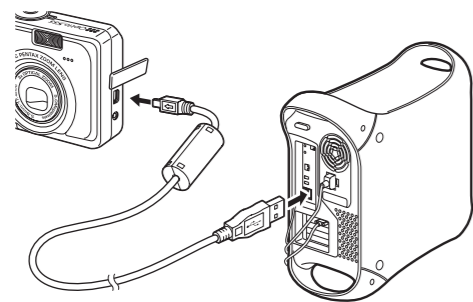

- 3 Turn your camera on.
The camera is recognized as [untitled] ([NO_NAME] in Mac OS X) on the desktop. The drive name can be changed.

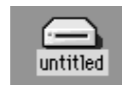

If the SD Memory Card has a volume label, the volume label name appears instead of [untitled]. A new unformatted SD Memory Card may show the manufacturer name or model number.

When the camera is connected to a Macintosh with the USB cable, the power indicator blinks to indicate that the camera is communicating with the Macintosh.

Disconnecting the Camera from Your Macintosh

- 1 Drag [untitled] on the desktop to the trash.
If the SD Memory Card has a volume label, drag the icon of that name to the trash.
- 2 Disconnect the USB cable from your Macintosh and the camera.

If the camera (removable disk) is being used by an application such as ACDSee for PENTAX, the camera cannot be disconnected until the application is closed.

The camera will be turned off when the USB cable is disconnected.

Transferring Images

See your Macintosh user's manual for how to copy or move files.

Even if camera images are not transferred, they can be directly displayed on the Macintosh from a camera connected to the Macintosh.

To edit images, first transfer them to your Macintosh.

Product Registration on the Internet

Please click [Product Registration] on the software selection screen in **Step 2**.
A world map for Internet Product Registration is displayed.

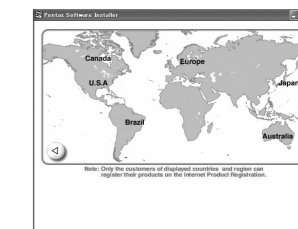

If your PC is connected to the Internet, click the displayed country or region and then follow the instructions to register your product.

Thank you very much for your cooperation.

Only customers in displayed countries and regions can register their products on the Internet Product Registration.